

harman/kardon

H A Harman International Company
250 Crossways Park Drive, Woodbury, New York 11797
www.harmankardon.com
© 1999 Harman Kardon, Incorporated
Printed in China Part #1111-AVR5000M
6311-004-010

AVR 500 Audio/Video Receiver

OWNER'S MANUAL

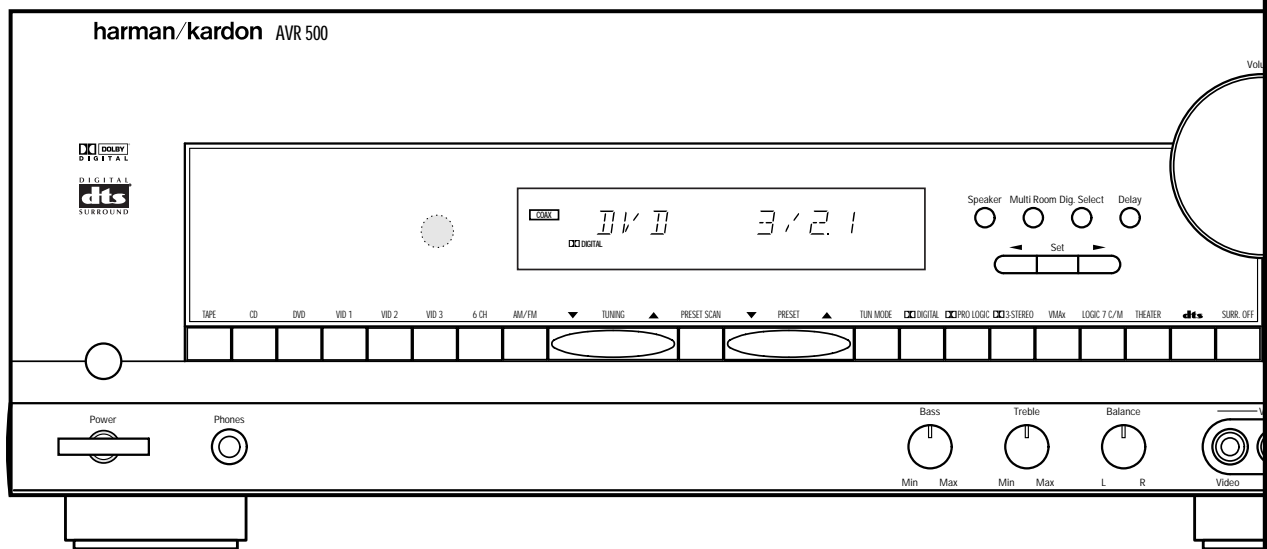

harman/kardon®

Power for the digital revolution.™

AVR 500 Audio/Video Receiver

3	Introduction
4	Safety Information
4	Unpacking
5	Front Panel Controls
7	Front Panel Information Display
8	Rear Panel Connections
10	Remote Control Functions
13	Installation and Connections
15	System Configuration
20	Operation
20	Basic Operation
20	Using the On-Screen Display
21	Source Selection
21	Surround Mode Selection
22	Surround Mode Chart
23	Digital Audio Playback
24	Tuner Operation
25	Tape Recording
25	Output Level Trim Adjustment
25	6-Channel Direct Input
25	Memory Backup
26	Multiroom Operation
27	Programming the Remote
27	Direct Code Entry
27	Auto Search Method
27	Code Readout
28	Programmed Device Functions
28	Macro Programming
28	Volume Punch-Through
29	Reassigning Device Control Selectors
30	Function List
31	Setup Code Tables: TV
34	Setup Code Tables: VCR
36	Setup Code Tables: CD
36	Setup Code Tables: DVD
37	Setup Code Tables: DVD/LD
37	Setup Code Tables: CABLE
37	Setup Code Tables: SAT
38	Troubleshooting Guide
38	Processor Reset
39	Technical Specifications

Typographical Conventions

In order to help you use this manual with the remote control, front-panel controls and rear-panel connections, certain conventions have been used.

EXAMPLE – (bold type) indicates a specific remote control or front-panel button, or rear-panel connection jack

EXAMPLE – (OCR type) indicates a message that is visible on the front-panel information display

EXAMPLE – (outlined type) indicates a lit indicator in the front-panel information display

1 – (number in a square) indicates a specific front-panel control

1 – (number in an oval) indicates a button or indicator on the remote

1 – (number in a circle) indicates a rear-panel connection

A – (letter in a circle) indicates an indicator in the front-panel display

Introduction

Thank you for choosing Harman Kardon!

With the purchase of a Harman Kardon AVR 500 you are about to begin many years of listening enjoyment. The AVR 500 has been custom designed to provide all the excitement and detail of movie sound tracks and every nuance of musical selections. With onboard Dolby* Digital and DTS† Decoding, the AVR 500 delivers six discrete channels of audio that take advantage of the digital sound tracks from the latest DVD and LD releases and Digital Television broadcasts.

While complex digital systems are hard at work within the AVR 500 to make all of this happen, hookup and operation are simple. Color-keyed connections, a backlit, programmable remote control, and on-screen menus make the AVR 500 easy to use. To obtain the maximum enjoyment from your new receiver, we urge you to take a few minutes to read through this manual. This will ensure that connections to speakers, source playback units and other external devices are made properly. In addition, a few minutes spent learning the functions of the various controls will enable you to take advantage of all the power the AVR 500 is able to deliver.

If you have any questions about this product, its installation or its operation, please contact your retailer or custom installer. They are your best local source of information.

Description and Features

The AVR 500 is a full-featured A/V receiver, incorporating a wide variety of listening options. In addition to Dolby Digital and DTS decoding, Dolby Pro Logic* and Dolby 3 Stereo are available for compatibility with the tens of thousands of movies and television programs encoded with analog surround information. In addition, Harman Kardon is the only receiver brand to offer Logic 7® to create wider, enveloping sound field environments and more defined pans and flyovers. Our exclusive VMaX® delivers a spacious sound field even when only two front speakers are available.

A total of four audio/video inputs, each with both composite and S-Video, as well as three additional audio-only inputs, are selected through a learning remote control and an easy-to-read front-panel display or on-screen graphics through a TV monitor. Multiroom operation is available with independent source and volume selection.

The AVR 500's powerful amplifier uses traditional Harman Kardon high-current design technologies to meet the wide dynamic range of any program selection.

Harman Kardon invented the high-fidelity receiver over forty-five years ago. With state-of-the-art circuitry and time-honored circuit designs, the AVR 500 is one of the finest receivers ever offered by Harman Kardon.

- Onboard Dolby Digital and DTS Decoding
- Harman Kardon's Exclusive VMaX and Logic 7 Surround Modes
- Coax and Optical Digital Inputs and Outputs
- On-Screen Menu Displays
- Backlit, Programmable Remote Control
- Composite and S-Video Switching
- Complete Multiroom Control
- 6-Channel Direct Input and Preamp Output for ALL Channels Permits Ease of Expansion

CAUTION

RISK OF ELECTRIC SHOCK DO NOT OPEN

CAUTION: To prevent electric shock, do not remove the grounding plug on the power cord, or use any plug or extension cord that does not have a grounding plug provided.

Make certain that the AC outlet is properly grounded.

Do not use an adapter plug with this product.



The lightning flash with arrowhead symbol, within an equilateral triangle, is intended to alert the user to the presence of uninsulated "dangerous voltage" within the product's enclosure that may be of sufficient magnitude to constitute a risk of electric shock to persons.



The exclamation point within an equilateral triangle is intended to alert the user to the presence of important operating and maintenance (servicing) instructions in the literature accompanying the appliance.

Safety Information

Important Safety Information

Verify Line Voltage Before Use

Your AVR 500 has been designed for use with 120-volt AC current. Connection to a line voltage other than that for which it is intended can create a safety and fire hazard and may damage the unit.

If you have any questions about the voltage requirements for your specific model, or about the line voltage in your area, contact your selling dealer before plugging the unit into a wall outlet.

Do Not Use Extension Cords

To avoid safety hazards, use only the power cord attached to your unit. We do not recommend that extension cords be used with this product. As with all electrical devices, do not run power cords under rugs or carpets or place heavy objects on them. Damaged power cords should be replaced immediately with cords meeting factory specifications.

Handle the AC Power Cord Gently

When disconnecting the power cord from an AC outlet, always pull the plug, never pull the cord. If you do not intend to use the unit for any considerable length of time, disconnect the plug from the AC outlet.

Do Not Open the Cabinet

There are no user-serviceable components inside this product. Opening the cabinet may present a shock hazard, and any modification to the product will void your guarantee. If water or any metal object such as a paper clip, wire or a staple accidentally falls inside the unit, disconnect it from the AC power source immediately, and consult an authorized service station.

CATV or Antenna Grounding

If an outside antenna or cable system is connected to this product, be certain that it is grounded so as to provide some protection against voltage surges and static charges. Section 810 of the National Electrical Code, ANSI/NFPA No. 70-1984, provides information with respect to proper grounding of the mast and supporting structure, grounding of the lead-in wire to an antenna discharge unit, size of grounding conductors, location of antenna discharge unit, connection to grounding electrodes and requirements of the grounding electrode.

NOTE TO CATV SYSTEM INSTALLER: This reminder is provided to call the CATV (Cable TV) system installer's attention to article 820-

40 of the NEC that provides guidelines for proper grounding and, in particular, specifies that the cable ground shall be connected to the grounding system of the building, as close to the point of cable entry as possible.

Installation Location

- To assure proper operation and to avoid the potential for safety hazards, place the unit on a firm and level surface. When placing the unit on a shelf, be certain that the shelf and any mounting hardware can support the weight of the product.
- Make certain that proper space is provided both above and below the unit for ventilation. If this product will be installed in a cabinet or other enclosed area, make certain that there is sufficient air movement within the cabinet. Under some circumstances a fan may be required.
- Do not place the unit directly on a carpeted surface.
- Avoid installation in extremely hot or cold locations, or an area that is exposed to direct sunlight or heating equipment.
- Avoid moist or humid locations.
- Do not obstruct the ventilation slots on the top of the unit, or place objects directly over them.

Cleaning

When the unit gets dirty, wipe it with a clean, soft, dry cloth. If necessary, wipe it with a soft cloth dampened with mild soapy water, then a fresh cloth with clean water. Wipe dry immediately with a dry cloth. NEVER use benzene, aerosol cleaners, thinner, alcohol or any other volatile cleaning agent. Do not use abrasive cleaners, as they may damage the finish of metal parts. Avoid spraying insecticide near the unit.

Moving the Unit

Before moving the unit, be certain to disconnect any interconnection cords with other components, and make certain that you disconnect the unit from the AC outlet.

Important Information for the User

This equipment has been tested and found to comply with the limits for a Class-B digital device, pursuant to Part 15 of the FCC Rules. The limits are designed to provide reasonable protection against harmful interference in a residential installation. This equipment generates, uses and can radiate radio-frequency energy and, if not installed and used in accordance with the instructions, may cause harmful inter-

ference to radio communication. However, there is no guarantee that harmful interference will not occur in a particular installation. If this equipment does cause harmful interference to radio or television reception, which can be determined by turning the equipment off and on, the user is encouraged to try to correct the interference by one or more of the following measures:

- Reorient or relocate the receiving antenna.
- Increase the separation between the equipment and receiver.
- Connect the equipment into an outlet on a circuit different from that to which the receiver is connected.
- Consult the dealer or an experienced radio/TV technician for help.

This device complies with Part 15 of the FCC Rules. Operation is subject to the following two conditions: (1) this device may not cause harmful interference, and (2) this device must accept interference received, including interference that may cause undesired operation.

NOTE: Changes or modifications may cause this unit to fail to comply with Part 15 of the FCC Rules and may void the user's authority to operate the equipment.

Unpacking

The carton and shipping materials used to protect your new receiver during shipment were specially designed to cushion it from shock and vibration. We suggest that you save the carton and packing materials for use in shipping if you move, or should the unit ever need repair.

To minimize the size of the carton in storage, you may wish to flatten it. This is done by carefully slitting the tape seams on the bottom and collapsing the carton. Other cardboard inserts may be stored in the same manner. Packing materials that cannot be collapsed should be saved along with the carton in a plastic bag.

If you do not wish to save the packaging materials, please note that the carton and other sections of the shipping protection are recyclable. Please respect the environment and discard those materials at a local recycling center.

Front Panel Controls

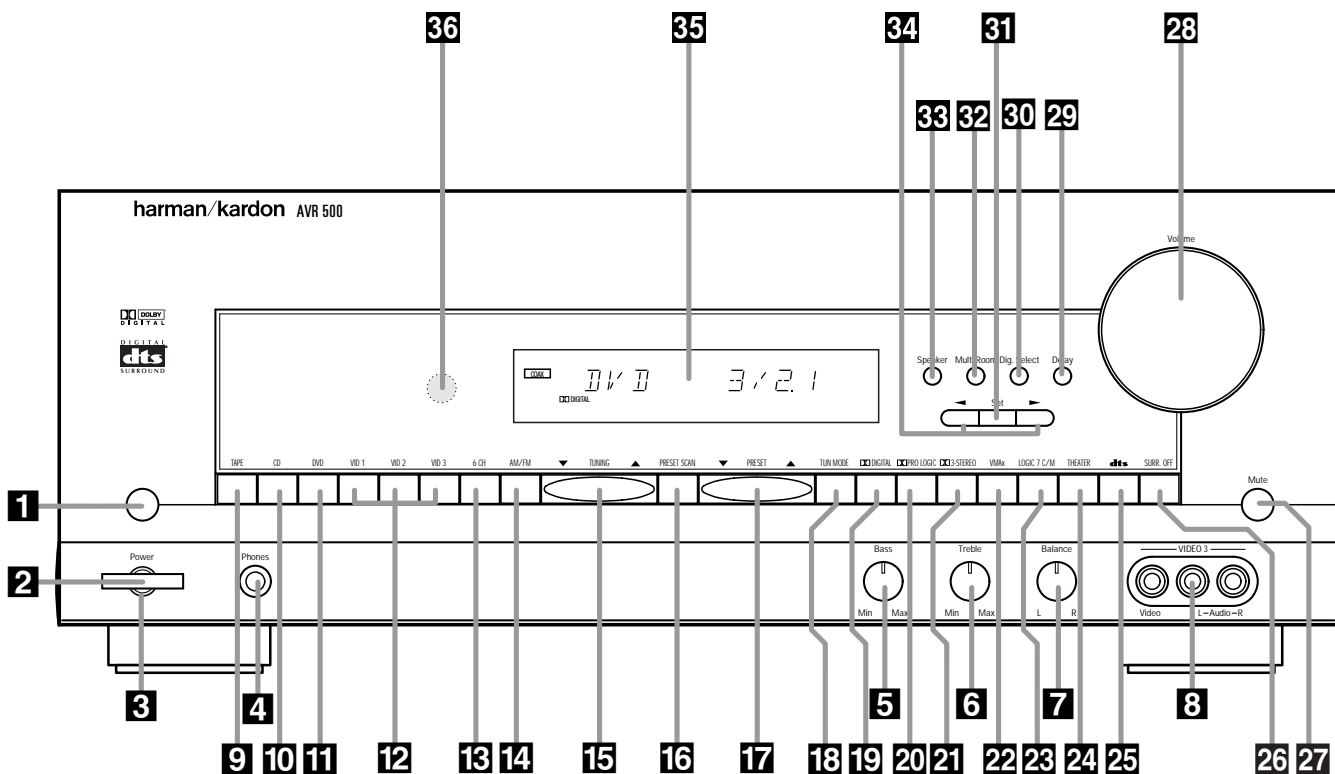

- 1** Main Power Switch
- 2** System Power Control
- 3** Power Indicator
- 4** Headphone Jack
- 5** Bass Control
- 6** Treble Control
- 7** Balance Control
- 8** Video 3 Inputs
- 9** Tape Selector
- 10** CD Input Selector
- 11** DVD Input Selector
- 12** Video Input Selectors
- 13** 6-Channel Direct Selector
- 14** AM/FM Selector
- 15** Tuning Button
- 16** Preset Scan
- 17** Preset Stations Selector
- 18** Tuner Mode
- 19** Dolby Digital Selector
- 20** Dolby Pro Logic Selector
- 21** Dolby 3 Stereo Selector
- 22** VMAX mode Selector
- 23** Logic 7 Mode Selector
- 24** Theater Mode Selector
- 25** DTS Selector
- 26** Surround Off
- 27** Mute
- 28** Volume Control
- 29** Delay
- 30** Digital Input Selector
- 31** Set Button
- 32** Multiroom Selector
- 33** Speaker Select Button
- 34** Selector Buttons
- 35** Information Display
- 36** Remote Sensor

1 Main Power Switch: Press this button to apply power to the AVR 500. When the switch is pressed in, the unit is placed in a Standby mode, as indicated by the amber LED **3** surrounding the **System Power Control** **2**. This button MUST be pressed in to operate the unit. To turn the unit off and prevent the use of the remote control, this switch should be pressed until it pops out from the front panel so that the word "OFF" may be read at the top of the switch.

NOTE: In normal operation this switch is left in the "ON" position.

2 System Power Control: When the **Main Power Switch** **1** is "ON," press this button

to turn on the AVR 500; press it again to turn the unit off. Note that the **Power Indicator** surrounding the switch **3** will turn green when the unit is on.

3 Power Indicator: This LED will illuminate in amber when the unit is in the Standby mode to signal that the unit is ready to be turned on. When the unit is in operation, the indicator will turn green.

4 Headphone Jack: This jack may be used to listen to the AVR 500's output through a pair of headphones. Be certain that the headphones have a standard 1/4" stereo phone plug. Note that the main room speakers will automatically be turned off when the headphone jack is in use.

5 Bass Control: Turn this control to modify the low-frequency output of the left/right channels by as much as $\pm 10\text{dB}$. Set this control to a suitable position for your taste or room acoustics.

6 Treble Control: Turn this control to modify the high-frequency output of the left/right channels by as much as $\pm 10\text{dB}$. Set this control to a suitable position for your taste or room acoustics.

7 Balance Control: Turn this control to change the relative volume for the front left/right channels.

NOTE: For proper operation of the surround modes this control should be at the midpoint or "12 o'clock" position.

Front Panel Controls

8 Video 3 Inputs: These audio/video inputs may be used for temporary connection of video games, camcorders, digital still cameras or portable audio products. To select a source connected to these jacks, press the **Vid 3 Input Selector 12**.

9 Tape Selector: Press this button to select the device connected to the **Tape In** jacks **25** as the listening source.

10 CD: Press this button to select the device connected to the **CD Input** jacks **7** as the listening source.

11 DVD Input Selector: Press this button to select the device connected to the **DVD Input** jacks **5** as the listening and viewing source.

12 Video Input Selectors: Press one of these buttons to select a source connected to the rear panel **Video** inputs **1** **20**, or the front panel **Video 3** input **8**.

13 6-Channel Direct Selector: Press this button to select the output of an optional, external 6-channel decoder connected to the **6-Ch Direct** inputs **6** as the listening source.

14 AM/FM: Press this button to select the tuner as the AVR 500's input source. When it is first pressed the last station tuned will be heard. Press it again to change between AM and FM bands.

15 Tuning Button: Press the left side of the button to tune lower frequency stations and the right side of the button to tune higher frequency stations. When a station with a strong signal is reached, the **TUNED** indicator **U** will illuminate in the **Information Display 35**.

To tune manually, tap the button lightly and note that the tuner will step up one frequency per button press. When the button is held for a few seconds you will note that the unit will quickly search the frequency band. Release it once the fast tuning starts and the tuner will automatically scan for the next station with an acceptable signal and then stop.

16 Preset Scan: Press this button to automatically scan through the stations that have been programmed in the AVR 500's memory. The tuner will play five seconds of each station before moving to the next preset station. To stop the scan when the desired station is heard, press the button again. (See pages 24–25 for more information on the tuner memory system.)

17 Preset Stations Selector: Press this button to select stations that have been entered into the preset memory. (See pages 24–25 for more information on tuner programming.)

18 Tuner Mode: Press this button to select the stereo or mono mode for FM tuning. In the STEREO mode a **Stereo** indicator **T** will illuminate in the information display, and stereo reception will be provided when stations are transmitting stereo signals. In the MONO mode the left and right signals from stereo broadcasts will be mixed together. Select MONO for better reception of weak signals.

19 Dolby Digital Selector: Press this button to select the Dolby Digital surround mode when listening to a program that carries Dolby Digital information. (See pages 21–24 for more information on surround modes and digital audio.)

20 Dolby Pro Logic Selector: Press this button to select the Dolby Pro Logic surround mode when listening to an analog program that is encoded with surround-sound information. (See page 21–23 for more information on surround modes.)

21 Dolby 3 Stereo Selector: Press this button to select the Dolby 3 Stereo listening mode. This mode is used primarily when a center channel speaker but no surround speakers, are installed. (See pages 22 for more information on surround modes.)

22 VMAx Mode Selector: Press this button to activate the VMAx mode. When only front left and right speakers are installed, VMAx uses proprietary circuits to create a virtual surround sound. (See pages 22 for more information on VMAx.)

23 Logic 7 Mode Selector: Press this button to activate the Logic 7 modes. One press brings up the Logic 7 Cinema mode, another press activates the Logic 7 Music mode. When a stereo source is in use, Logic 7 delivers sound to all five speakers, creating a multichannel sound field. (See page 22 for more information on Logic 7.)

24 Theater Mode Selector: Press this button to activate the Theater mode as an alternate surround mode when stereo sources are in use.

25 DTS Selector: Press this button to select DTS decoding when listening to an audio or video program that is encoded in the DTS format. (See pages 22–24 for more information on surround modes and digital audio.)

26 Surround Off: Press this button to turn off all surround processing and to listen to a program in traditional stereo from the left front and right front speakers only.

27 Mute: Press this button to momentarily silence the speaker and headphone outputs of the AVR 500.

28 Volume Control: Turn the knob clockwise to increase volume, counterclockwise to decrease the volume. If the AVR is muted, adjusting volume control will automatically release the unit from the silenced condition.

29 Delay: Press this button to begin the sequence of steps required to enter delay time settings. (See pages 18–19 for more information on delay times.)

30 Digital Input Selector: When playing a source that has a digital output, press this button to select between the **Optical 28** and **Coaxial 24 Digital** inputs. (See pages 23–24 for more information on digital audio.)

31 Set Button: When making choices during the setup and configuration process, press this button to enter the desired setting as shown in the **Information Display 35**, into the AVR 500's memory.

32 Multiroom Selector: Press this button to activate the AVR 500's Multiroom system. (See page 26 for complete information on Multiroom operation.)

33 Speaker Select Button: Press this button to begin the process of selecting the speaker positions that are used in your listening room. (See page 16 for more information on setup and configuration.)

34 Selector Buttons: When you are establishing the AVR 500's configuration settings, use these buttons to select between the choices available, as shown in the **Information Display 35**.

35 Information Display: This display delivers messages and status indications to help you operate the receiver. (See page 7 for a complete explanation of the Information Display.)

36 Remote Sensor Window: The sensor behind this window receives infrared signals from the remote control. Aim the remote at this area and do not block or cover it unless an external remote sensor is installed.

Front Panel Information Display

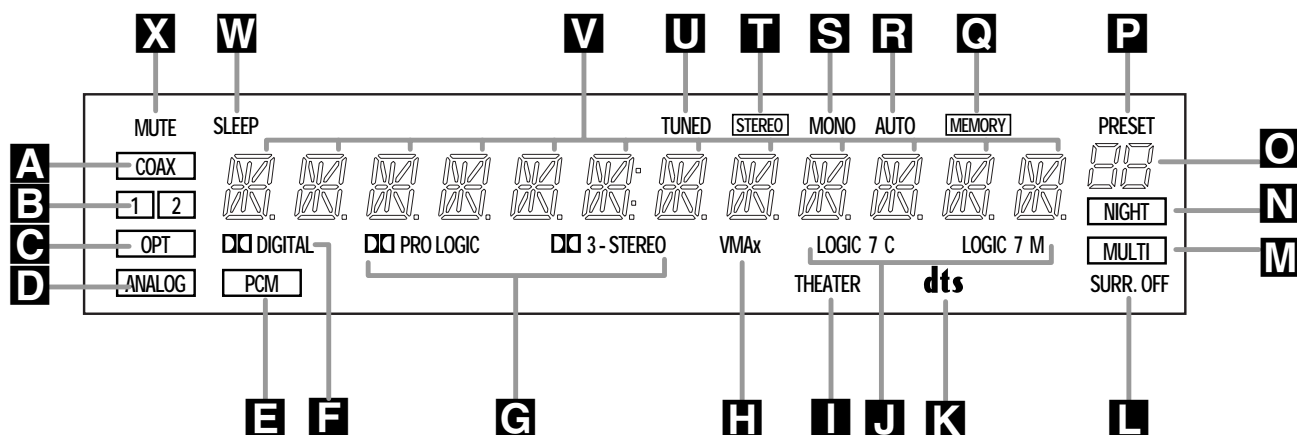

- A** Coax Source
- B** Digital Source Input Number
- C** Optical Source
- D** Analog Source Indicator
- E** PCM Indicator
- F** Dolby Digital Indicator
- G** Analog Dolby Surround Mode Indicators
- H** VMAx Mode Indicator

- I** Theater Mode Indicator
- J** Logic 7 Mode Indicators
- K** DTS Mode Indicator
- L** Surround Off
- M** Multiroom System Indicator
- N** Night Mode Indicator
- O** Preset Number
- P** Preset Indicator

- Q** Memory
- R** Auto
- S** Mono Indicator
- T** Stereo Indicator
- U** Tuned Indicator
- V** Main Information Display
- W** Sleep Indicator
- X** Mute

A Coax Source: This indicator illuminates when a digital source is in use via a connection to the **Coaxial Digital** inputs 24.

B Digital Source Input Number: These indicators tell you which of the two digital inputs is selected. This indicator works in conjunction with the **Coax Source A** and **Optical Source C** indicators to show which form of digital signal is in use.

C Optical Source: This indicator illuminates when a digital source is in use via a connection to the **Optical Digital** input 25.

D Analog Source Indicator: This indicator illuminates when an analog input source is in use.

E PCM Indicator: This indicator illuminates to show that a standard PCM (S/P-DIF) digital audio signal is being decoded by the digital-to-analog converter.

F Dolby Digital Indicator: This indicator illuminates when a Dolby Digital source is being played.

G Analog Dolby Surround Mode Indicators: These indicators illuminate when one of the analog (matrix) Dolby Surround modes is in use.

H VMAx Mode Indicator: This indicator illuminates to show that the VMAx mode is in use.

I Theater Mode Indicator: This indicator illu-

minates to show that the Theater mode is in use.

J Logic 7 Mode Indicators: These indicators illuminate when the Logic 7 mode is in use. **LOGIC 7C** appears for the Cinema version of Logic 7, **LOGIC 7M** appears for the Music version of Logic 7.

K DTS Mode Indicator: This indicator illuminates when a DTS-encoded source is playing.

L Surround Off: This indicator illuminates when the surround processing has been disabled by pressing the **Surround Off** button 26. When this indicator is lit, the AVR 500 will play traditional stereo sound using the front-left and front-right speakers only.

M Multiroom System Indicator: This indicator illuminates when the multiroom system is in operation. (See page 26 for more information on the multiroom system.)

N Night Mode Indicator: This indicator lights when the AVR 500 is in the Night mode, which preserves the dynamic range of digital program material at low volume levels.

O Preset Number: This two-digit display indicates the station preset number that is currently in use, or that is being entered.

P Preset Indicator: This indicator illuminates when a station previously entered into the preset memory is tuned. The number that appears below the indicator is the preset station's memory.

Q Memory: This indicator flashes when entering presets and other information into the tuner's memory.

R Auto: This indicator illuminates when the Auto mode is in use for FM tuning.

S Mono Indicator: This indicator illuminates when the tuner has been placed in the monaural mode by pressing the **Tune Mode** button 18. Set the tuner for mono listening to reduce noise and improve the quality of distant stereo signals.

T Stereo Indicator: This indicator illuminates when an FM station is being tuned in stereo.

U Tuned Indicator: This indicator illuminates when a station is being received with sufficient signal strength to provide acceptable listening quality.

V Main Information Display: This display shows messages relating to the status, input source, surround mode, tuner, volume level or other aspects of unit's operation.

W Sleep Indicator: This indicator is illuminated when the Sleep function is in use. The number that appears above the indicator is the number of minutes remaining before the AVR 500 will return to the Standby mode.

X Mute: This indicator illuminates to remind you that the AVR 500's output has been silenced by pressing the **Mute** button 27 6. Press the Mute button again to return to the previously selected output level.

Rear Panel Connections

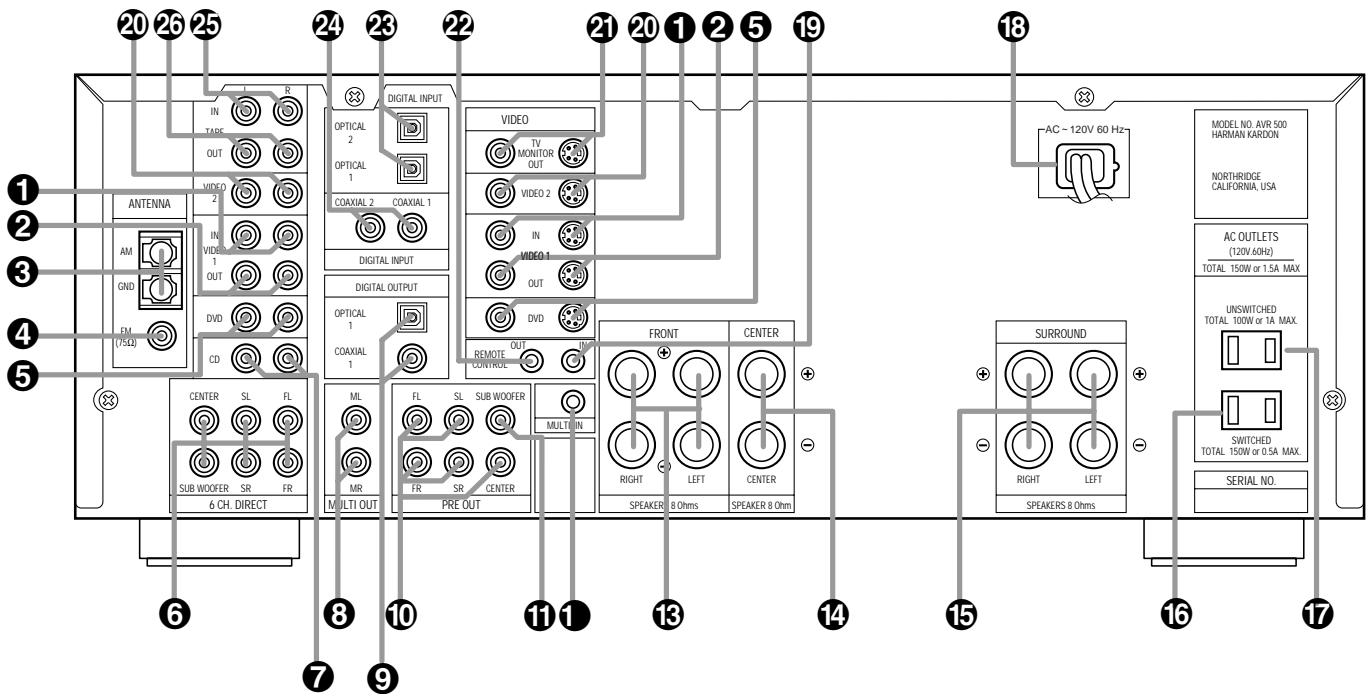

- 1 Video 1 Inputs
- 2 Video 1 Outputs
- 3 AM Antenna
- 4 FM Antenna
- 5 DVD Inputs
- 6 6-Channel Direct Inputs
- 7 CD Inputs
- 8 Multiroom Audio Outputs
- 9 Digital Outputs
- 10 Preamp Outputs
- 11 Subwoofer Output
- 12 Multiroom IR Input
- 13 Front Speaker Terminals
- 14 Center Speaker Terminals
- 15 Surround Speaker Terminals
- 16 Switched AC Outlet
- 17 Unswitched AC Outlet
- 18 AC Power Cord
- 19 Remote IR Input
- 20 Video 2 Inputs
- 21 TV Monitor Video Outputs
- 22 Remote IR Output
- 23 Optical Digital Inputs
- 24 Coaxial Digital Inputs
- 25 Tape Inputs
- 26 Tape Outputs

NOTE: For all video inputs and outputs **1 2 5 20 21**, the same number is used to indicate the audio, composite-video and S-Video connections related to that input. This accounts for the same number appearing in more than one place on the rear-panel drawing.

Rear Panel Connections

1 Video 1 Inputs: Connect these jacks to the audio and video PLAY/OUT jacks of a VCR.

2 Video 1 Outputs: Connect these jacks to the audio and video RECORD/IN jacks of a VCR.

3 AM Antenna: Connect the AM loop antenna supplied with the receiver to these terminals. If an external AM antenna is used, make connections to the **AM** and **GND** terminals in accordance with the instructions supplied with the antenna.

4 FM Antenna: Connect the supplied indoor or the optional external FM antenna to this terminal.

5 DVD Inputs: Connect the analog audio outputs and composite video output of a DVD or LD player to these jacks.

6 6-Channel Direct Inputs: If an external digital audio decoder is used, connect the outputs of that decoder to these jacks.

7 CD Inputs: Connect these jacks to the output of a compact disc player or CD changer.

8 Multiroom Audio Outputs: Connect these jacks to the inputs of an optional audio power amplifier so that the input selected by the multiroom control system will be heard in a remote room.

9 Digital Audio Outputs: Connect these jacks to the matching digital input connector on a digital recorder such as a CD-R or MiniDisc recorder.

10 Preamp Outputs: If external power amplifiers are used for any channels, connect them to these jacks.

11 Subwoofer Output: Connect this jack to the line-level input of a powered subwoofer. If an external subwoofer amplifier is used, connect this jack to the subwoofer amplifier input.

12 Multiroom IR Input: Connect the output of an IR sensor in a remote room to this jack to operate the AVR 500's multiroom control system.

13 Front Speaker Terminals: Connect the front left/right speakers to these terminals.

14 Center Speaker Terminals: Connect the center speaker to these terminals.

15 Surround Speaker Terminals: Connect the surround speakers to these terminals.

NOTE: When making connections to the Speaker Terminals **13 14 15** always be certain to maintain correct polarity between the speaker's terminals and those on the AVR by connecting red (+) terminals to red and black (-) terminals to black. See page 13 for more information on speaker polarity.

16 Switched AC Outlet: This outlet may be used to power any device that you wish to have turn on when the unit is turned on with the **System Power Control** switch **2**.

17 Unswitched AC Outlet: This outlet may be used to power any AC device. The power will remain on at this outlet regardless of whether the AVR 500 is on or off.

NOTE: The power consumption of the device plugged into each of these outlets **16 17** should not exceed 100 watts.

18 AC Power Cord: Connect the AC plug to a nonswitched AC wall output.

19 Remote IR Input: If the AVR 500's front-panel IR sensor is blocked due to cabinet doors or other obstructions, an external IR sensor may be used. Connect the output of the sensor to this jack.

20 Video 2 Inputs: Connect these jacks to the audio and video outputs of a TV Tuner, Cable TV converter box, satellite receiver or any other audio/video source.

21 TV Monitor Video Output: Connect this jack to the composite or S-Video input of a TV monitor or video projector to view the on-screen menus and the output of any standard video source selected by the receiver's video switcher.

22 Remote IR Output: This connection permits the IR sensor in the receiver to serve other remote controlled devices. Connect this jack to the "IR IN" jack on Harman Kardon or other compatible equipment.

23 Optical Digital Inputs: Connect the optical digital output from a DVD player, HDTV receiver, LD player or CD player to these jacks. The signal may be either a Dolby Digital signal, a DTS signal or a standard PCM digital source.

24 Coaxial Digital Inputs: Connect the coax digital output from a DVD player, HDTV receiver, LD player or CD player to these jacks. The signal may be either a Dolby Digital signal, DTS signal or a standard PCM digital source.

25 Tape Inputs: Connect these jacks to the PLAY/OUT jacks of an audio recorder.

26 Tape Outputs: Connect these jacks to the RECORD/INPUT jacks of an audio recorder.

Remote Control Functions

- 1 AVR Selector
- 2 CD/Tape/DVD Input Selectors
- 3 Video Remote Selectors
- 4 Power Off Button
- 5 Test Tone
- 6 Mute
- 7 ▲/▼ Buttons
- 8 Channel-Select Button
- 9 Set Button
- 10 ◀ Button
- 11 Digital Select
- 12 6-Ch. Direct Input
- 13 Video Input Selectors
- 14 AM/FM Tuner Select
- 15 Tuner Mode
- 16 Memory Button
- 17 Numeric Keys
- 18 Macro 1/2 Buttons
- 19 OSD Button
- 20 Light Button
- 21 Direct/Macro Button
- 22 Clear/Macro Button
- 23 Preset Up/Down
- 24 Tuning Up/Down
- 25 Forward/Reverse Transport Buttons
- 26 Night Mode
- 27 Multi-Room
- 28 Delay/Prev. Ch.
- 29 ▶ Button
- 30 Speaker Select
- 31 Surround Mode Selector
- 32 Volume Up/Down
- 33 Sleep Button

NOTE: The function names shown here are each button's feature when used with the AVR. Most buttons have additional functions when used with other devices. See page 30 for a list of these functions.

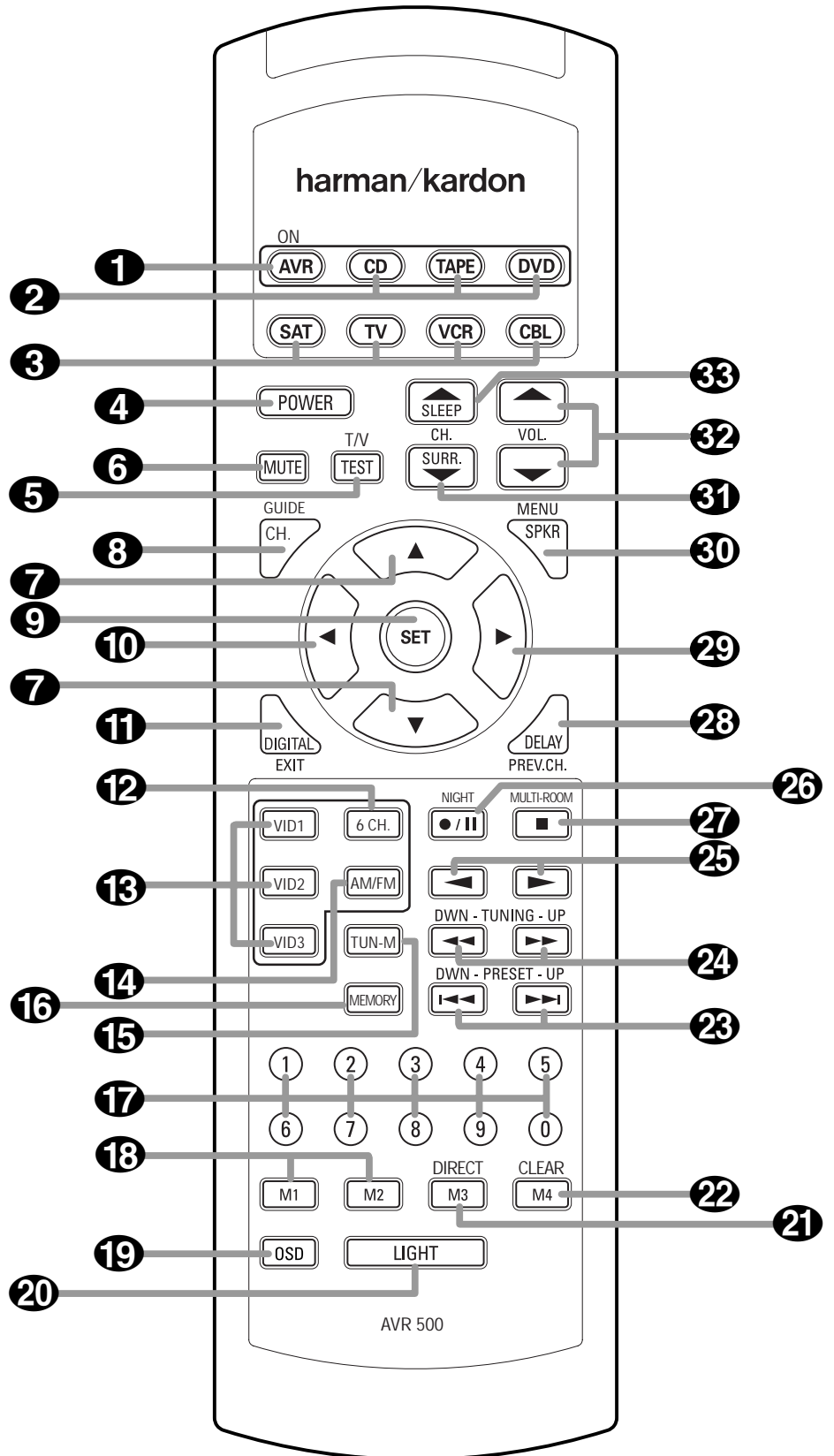

Remote Control Functions

IMPORTANT NOTE: The AVR 500's remote may be programmed to control up to eight devices, including the AVR 500. Before using the remote, it is important to remember to press the **Device Control Selector** button **1** **2** **3** that corresponds to the unit you wish to operate. In addition, the AVR 500's remote is shipped from the factory to operate the AVR 500 and most Harman Kardon CD or DVD players and cassette decks. The remote is also capable of operating a wide variety of other products using the control codes that are part of the remote. Before using the remote with other products, follow the instructions on pages 27–29 to program the proper codes for the products in your system.

It is also important to remember that many of the buttons on the remote take on different functions, depending on the product selected using the Device Control Selectors. The descriptions shown here primarily detail the functions of the remote when it is used to operate the AVR 500. (See page 29 for information about alternate functions for the remote's buttons.)

1 AVR Selector: Pressing this button will switch the remote so that it will operate the AVR's functions. If the AVR is in the Standby mode, it will also turn the AVR on.

2 CD/Tape/DVD Input Selectors: Pressing one of these buttons will perform three actions at the same time. First, if the AVR is not turned on, this will power up the unit. Next, it will select the source shown on the button as the input to the AVR. Finally, it will change the remote control so that it controls the device selected. After pressing one of these buttons you must press the **AVR Button** **1** again to operate the AVR's functions with the remote.

3 Video Remote Selectors: Press one of these buttons to use the remote to control the functions of the device shown on the button. (For more information on programming the remote to operate these devices, see pages 27–29.)

NOTE: As any of these buttons is pressed, it will briefly flash red to confirm your selection.

4 Power Off Button: Press this button to place the unit in the Standby mode. Note that this will turn off the main room functions, but if the Multiroom system is activated, it will continue to function.

5 Test Tone: Press this button to begin the sequence used to calibrate the AVR 500's output levels. (See pages 17–18 for more information on calibrating the AVR 500.)

6 Mute: Press this button to momentarily silence the AVR 500 or TV set being controlled, depending on which device has been selected.

When the AVR 500 remote is being programmed to operate another device, this button is pressed with the **Device Control Selector** button **2** **3** to begin the programming process. (See page 27 for more information on programming the remote.)

7 ▲/▼ Buttons: These are multi-purpose buttons. They will be used most frequently to select a surround mode. To change the surround mode, first press the **SURR/CH** ▼ button **31**. Next press these buttons to scroll up or down through the list of surround modes that appear in the **Information Display** **35**. These buttons are also used to increase or decrease output levels when configuring the unit with either the internal test tone or an external source. They are also used to enter delay time settings after the **Delay** button **23** has been pressed.

8 Channel-Select Button: This button is used to start the process of setting the AVR 500's output levels to an external source. Once this button is pressed, use the ▲/▼ buttons **7** to select the channel being adjusted, then press the **Set** button **9**, followed by the ▲/▼ buttons again, to change the level setting. (See page 25 for more information.)

9 Set Button: This button is used to enter settings into the AVR 500's memory. It is also used in the setup procedures for delay time, speaker configuration and channel output level adjustment.

10 ◀ Button: This button is used to change the menu selection or setting during some of the setup procedures for the AVR.

11 Digital Select: Press this button to assign one of the digital inputs **23** **24** to a source. (See page 23 for more information on using digital inputs.)

12 6-Ch. Direct Inputs: Press this button to select the component connected to the 6-Ch. direct Input **6** as the source

13 Video Input Selectors: Press this button to select one of the video inputs as the listening and viewing source.

14 AM/FM Tuner Select: Press this button to select this AVR's tuner as the listening choice. Pressing this button when a tuner is in use will select between the AM and FM bands.

15 Tuner Mode: Press this button when the tuner is in use to select between automatic tuning and manual tuning. When the button is pressed so that the **AUTO** indicator **R** goes out, pressing the **Tuning** buttons **24** will move the frequency up or down in single-step increments. When the FM band is in use, pressing this button when a station's signal is weak will change to monaural reception, as indicated by the **MONO** indicator **S**. (See page 24 for more information.)

16 Memory Button: Press this button to enter a radio station into the AVR 500's preset memory. After pressing the button the **MEMORY** indicator **Q** will flash; you then have five seconds to enter a present memory location using the **Numeric Keys** **17**. (See pages 24–25 for more information.)

17 Numeric Keys: These buttons serve as a ten-button numeric keypad to enter tuner preset positions. They are also used to select channel numbers when **TV** has been selected on the remote, or to select track numbers on a CD, DVD or LD player, depending on how the remote has been programmed.

18 Macro 1–2 Buttons: These buttons are used to recall or enter the programming sequence for a preprogrammed Macro sequence. (See page 28 for more information on programming and using Macros.)

19 OSD Button: Press this button to view the on-screen displays.

20 Light Button: Press this button to activate the remote's built-in backlight for better legibility of the buttons in a darkened room.

21 Direct/Macro 3 Button: This button has two functions. Pressing it when the tuner is in use will start the sequence for direct entry of a station's frequency. After pressing the button simply press the proper **Numeric Keys** **17** to select a station. This button may also be used to store or recall a macro sequence. (See pages 24–25 for more information on the tuner, and page 28 for more information on programming and using Macros.)

Remote Control Functions

22 Clear/Macro 4 Button: This button may be used to store and recall a macro; it may also be programmed for use with other devices. (See page 28 for more information on macros.)

23 Preset Up/Down: When the tuner is in use, these buttons scroll through the stations that have been programmed into the AVR 500's memory. When some source devices, such as CD players, VCRs and cassette decks, are selected using the **Device Control Selectors 2 3**, these buttons will normally function as chapter step or track advance.

24 Tuning Up/Down: When the tuner is in use, these buttons will tune up or down through the selected frequency band. If the **Tuner Mode** button **15** has been pressed so that the **AUTO** indicator **R** is illuminated, pressing and holding the buttons for three seconds will cause the tuner to seek the next station with acceptable signal strength for quality reception. When the **AUTO** indicator **R** is NOT illuminated, pressing these buttons will tune stations in single-step increments. (See page 24 for more information.)

25 Forward/Reverse Transport Buttons: These buttons do not have any functions for the AVR, but they may be programmed for the forward/reverse play operation of a wide variety of CD or DVD players, and audio or video-cassette recorders. (See page 27 for more information on programming the remote.)

26 Night Mode: Press this button to activate the Night mode. This mode is available in specially encoded digital sources, and it preserves dialog (center channel) intelligibility at low volume levels.

27 Multiroom: Press this button to activate the Multiroom system or to begin the process of changing the input or volume level for the second zone. (See page 26 for more information on the Multiroom system.)

28 Delay/Prev Ch.: Press this button to begin the process for setting the delay times used by the AVR 500 when processing surround sound. After pressing this button, the delay times are entered by pressing the **Set** button **9** and then using the **▲/▼** buttons **7** to change the setting. Press the **Set** button again to complete the process. (See page 18–19 for more information.)

29 ► Button: Press this button to change a setting or selection when configuring many of the AVR's settings.

30 Speaker Select: Press this button to begin the process of configuring the AVR 500's Bass Management System for use with the type of speakers used in your system. Once the button has been pressed, use the **▲/▼** buttons **7** to select the channel you wish to set up. Press the **Set** button **9** and then select another channel to configure. When all adjustments have been completed, press the **Set** button twice to exit the settings and return to normal operation. (See page 16 for more information.)

31 Surround Mode Selector: Press this button to begin the process of changing the surround mode. After the button has been pressed, use the **▲/▼** buttons **7** to select the desired surround mode. (See page 21 for more information.) Note that this button is also used to tune channels when the TV is selected using the **Device Control**

Selector 2. When the AVR 500 remote is being programmed for the codes of another device, this button is also used in the "Auto Search" process. (See page 27 for more information on programming the remote.)

32 Volume Up/Down: Press these buttons to raise or lower the system volume.

33 Sleep Button: Press this button to place the unit in the Sleep mode. After the time shown in the display, the AVR 500 will automatically go into the Standby mode. Each press of the button changes the time until turn-off in the following order:

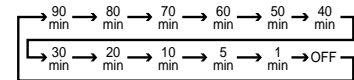

Press and hold the button for two seconds to turn off the Sleep mode setting.

Note that this button is also used to change channels on your TV when the TV is selected using the **Device Control Selectors 2 3**.

When the AVR 500 remote is being programmed for the codes of another device, this button is also used in the "Auto Search" process. (See page 27 for more information on programming the remote.)

Installation and Connections

System Installation

After unpacking the unit, and placing it on a solid surface capable of supporting its weight, you will need to make the connections to your audio and video equipment.

Audio Equipment Connections

We recommend that you use high-quality interconnect cables when making connections to source equipment and recorders to preserve the integrity of the signals.

When making connections to audio source equipment or speakers it is always a good practice to unplug the unit from the AC wall outlet. This prevents any possibility of accidentally sending audio or transient signals to the speakers that may damage them.

1. Connect the analog output of a CD player to the **CD** inputs **7**.

NOTE: When the CD player has both fixed and variable audio outputs it is best to use the fixed output unless you find that the input to the receiver is so low that the sound is noisy, or so high that the signal is distorted.

2. Connect the analog Play/Out jacks of a cassette deck, MD, CD-R or other audio recorder to the **Tape In** jacks **25**. Connect the analog Record/In jacks on the recorder to the **Tape Out** jacks **26** on the AVR 500.

3. Connect the output of any digital sources to the appropriate input connections on the AVR 500 rear panel. Note that the **Optical** and **Coaxial** digital inputs **23** **24** may be used with a Dolby Digital or DTS source or the output of a conventional CD or LD player's PCM (S/P-DIF) output.

4. Connect the **Coax or Digital Outputs** **9** on the rear panel of the AVR to the matching digital input connections on a CD-R or MiniDisc recorder.

5. Assemble the AM Loop Antenna supplied with the unit as shown below. Connect it to the **AM** and **GND** screw terminals **3**.

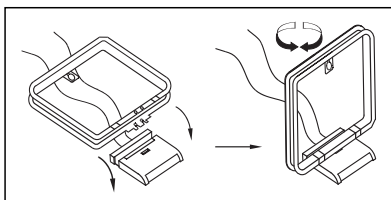

6. Connect the supplied FM antenna to the **FM (75 ohm)** connection **4**. The FM antenna may be an external roof antenna, an inside powered or wire lead antenna or a connection from a cable TV system. Note that if the antenna or connection uses 300-ohm twin-lead cable, you must use the 300-ohm-to-75-ohm adapter supplied with the unit to make the connection.

7. Connect the front, center and surround speaker outputs **13** **14** **15** to the respective speakers.

To assure that all the audio signals are carried to your speakers without loss of clarity or resolution, we suggest that you use high-quality speaker cable. Many brands of cable are available and the choice of cable may be influenced by the distance between your speakers and the receiver, the type of speakers you use, personal preferences and other factors. Your dealer or installer is a valuable resource to consult in selecting the proper cable.

Regardless of the brand of cable selected, we recommend that you use a cable constructed of fine, multistrand copper with a gauge of 14 or smaller. Remember that in specifying cable, the lower the number, the thicker the cable.

Cable with a gauge of 16 may be used for short runs of less than ten feet. We do not recommend that you use cables with an AWG equivalent of 18 or higher due to the power loss and degradation in performance that will occur.

Cables that are run inside walls should have the appropriate markings to indicate listing with UL, CSA or other appropriate testing agency standards. Questions about running cables inside walls should be referred to your installer or a licensed electrical contractor who is familiar with the NEC and/or the applicable local building codes in your area.

When connecting wires to the speakers, be certain to observe proper polarity. Remember to connect the "negative" or "black" wire to the same terminal on both the receiver and the speaker. Similarly, the "positive" or "red" wire should be connected to like terminals on the AVR 500 and speaker.

We also recommend that the length of cable used to connect speaker pairs be identical. For example, use the same length piece of cable to connect the front-left and front-right

or surround-left and surround-right speakers, even if the speakers are a different distance from the AVR 500.

NOTE: While most speaker manufacturers adhere to an industry convention of using black terminals for negative and red ones for positive, some manufacturers may vary from this configuration. To assure proper phase and optimal performance, consult the identification plate on your speaker or the speaker's manual to verify polarity. If you do not know the polarity of your speaker, ask your dealer for advice before proceeding, or consult the speaker's manufacturer.

8. Connections to a subwoofer are normally made via a line level audio connection from the **Subwoofer Output** **11** to the line-level input of a subwoofer with a built-in amplifier. When a passive subwoofer is used, the connection first goes to a power amplifier, which will be connected to one or more subwoofer speakers. If you are using a powered subwoofer that does not have line-level input connections, follow the instructions furnished with the speaker for connection information.

Video Equipment Connections

Video equipment is connected in the same manner as audio components. Again, the use of high-quality interconnect cables is recommended to preserve signal quality.

1. Connect a VCR's audio and video Play/Out jacks to the **Video 1 In** jacks **1** on the rear panel. The audio and Record/In jacks on the VCR should be connected to the **Video 1 Out** jacks **2** on the AVR 500.

2. Connect the analog audio and video outputs of a satellite receiver, cable TV converter or television set or any other video source to the **Video 2 In** jacks **20**.

3. Connect the analog audio and video outputs of a DVD or laser disc player to the **DVD** jacks **5**.

4. Connect the digital audio outputs of a DVD player, satellite receiver, cable box or HDTV converter to the appropriate **Optical** or **Coaxial Digital Inputs** **23** **24**.

5. Connect the **TV Monitor Out** **21** jacks on the receiver to the composite or S-Video input of your television monitor or video projector.

Installation and Connections

NOTE: The AVR 500 will accept both standard (composite) or S-Video signals. However, it will not convert signals from one video format type to the other.

System and Power Connections

The AVR 500 is designed for flexible use with multiroom systems, external control components and power amplifiers.

Main Room Remote Control Extension

If the receiver is placed behind a solid or smoked glass cabinet door, the obstruction may prevent the remote sensor from receiving commands. In this event, an optional remote sensor may be used. Connect the output of the remote sensor to the **Remote Cont. In** jack 19.

If other components are also prevented from receiving remote commands, only one sensor is needed. Simply use this unit's sensor or a remote eye by running a connection from the **Remote IR Output** jack 22 to the Remote In jack on Harman Kardon or other compatible equipment.

Multiroom IR Link

The remote room IR receiver should be connected to the AVR 500 via standard coaxial cable. Plug the IR connection cable into the **Multiroom** jack 1 on the AVR 500's rear panel.

If other Harman Kardon compatible source equipment is part of the main room installation, the **Remote IR Output** jack 22 on the rear panel should be connected to IR IN jack on the CD player or cassette deck. This will enable the remote room location to control source equipment functions in addition to the remote room input and volume.

NOTE: All remotely controlled components must be linked together in a daisy chain. Connect the **IR OUT** jack of one unit to the **IR IN** of the next to establish this chain.

Multiroom Audio Connections

Depending on the distance from the AVR 500 to the remote room, two options (A and B) are available:

A. Use high-quality, shielded audio interconnect cable from the AVR 500's location to the remote room. At the remote room, connect the interconnect cable to a stereo power amplifier. The amplifier will be connected to the room's speakers. No volume control is required, as the

AVR 500 and the remote IR link will provide that function. At the AVR 500, plug the audio interconnect cables into the **Multi Out** jacks 8 on the AVR 500's rear panel.

NOTE: The remote power amplifier must have signal sensing capability or be left on constantly to assure automatic operation at the remote room.

B. Place the amplifier that will provide power to the remote location speakers in the same room as the AVR 500, and connect the **Multi Out** jacks 8 on the rear panel of the AVR to the audio input of the remote room amplifier. Use the appropriate speaker wire to connect the optional power amplifier to the remote speakers. High-quality wire of at least AWG14 is recommended for long multiroom connections.

IMPORTANT NOTE: Any cables run inside walls should be CL3/FT4 rated, or carry any other certification that is required by the NEC or state and local building and electrical codes. To avoid interference, audio and speaker cables should not be parallel to, or run in the same conduits or path with, AC cables. If you have any questions about multiroom wiring, consult your dealer, custom installer or a licensed or low-voltage contractor.

External Audio Power Amplifier Connections

If desired, optional external power audio power amplifiers may be used with the AVR 500. Connections to these amplifiers are made by using audio interconnect cables connected to both the **Preamp Outputs** 10 on the rear panel and the audio input jacks of the external amplifiers.

External Audio Decoder Connection

To provide for ultimate flexibility, the AVR 500 may be used in conjunction with optional, external decoders for digital audio systems other than the AVR 500's own built-in Dolby Digital and DTS decoding system. If an external decoder is used, connect the output jacks of the decoder to the **6-Channel Direct** inputs 6, making sure to match channels.

These jacks may also be used for connections to devices such as DVD players or High Definition Television (HDTV) sets or decoders that feature built-in digital surround decoders. Although the digital decoding system in the AVR 500 will typically provide audio performance that is superior to other decoders, you may use these jacks to provide an additional 6-channel input for connec-

tion to a DVD player or HDTV set with a built-in decoder and discrete 6-channel analog outputs.

AC Power Connections

This unit is equipped with two accessory AC outlets. They may be used to power accessory devices, but they should not be used with high-current draw equipment such as power amplifiers. The total power draw to each outlet may not exceed 150 watts.

The **Switched** 16 outlet will receive power only when the unit is on. This is recommended for devices that have no power switch or a mechanical power switch that may be left in the "ON" position.

NOTE: Many audio and video products go into a Standby mode when they are used with switched outlets, and cannot be fully turned on using the outlet alone without a remote control command.

The **Unswitched** 17 outlet will receive power as long as the unit is plugged into a powered AC outlet.

Finally, when all connections are complete, plug the power cord into a nonswitched 120-volt AC wall outlet. You're almost ready to enjoy the AVR 500!

System Configuration

When all audio, video and system connections have been made, there are a few configuration adjustments that must be made. A few minutes spent to correctly configure and calibrate the unit will greatly add to your listening experience.

Speaker Selection and Placement

The placement of speakers in a multichannel home-theater system can have a noticeable impact on the quality of sound reproduced.

No matter which type or brand of speakers is used, the same model or brand of speaker should be used for the front-left, center and front-right speakers. This creates a seamless front soundstage and eliminates the possibility of distracting sonic disturbances that occur when a sound moves across mismatched front-channel speakers.

Speaker Placement

Depending on the type of center-channel speaker in use and your viewing device, place the center speaker either directly above or below your TV, or in the center behind a perforated front-projection screen.

Once the center-channel speaker is installed, position the left-front and right-front speakers so that they are as far away from one another as the center-channel speaker is from the preferred listening position. Ideally, the front-channel speakers should be placed so that their tweeters are no more than 24" above or below the tweeter in the center-channel speaker.

Depending on the specifics of your room acoustics and the type of speakers in use, you may find that imaging is improved by moving the front-left and front-right speakers slightly forward of the center-channel speaker. If possible, adjust all front loudspeakers so that they are aimed at ear height when you are seated in the listening position.

Using these guidelines, you'll find that it takes some experimentation to find the correct location for the front speakers in your particular installation. Don't be afraid to move things around until the system sounds correct. Optimize your speakers so that audio transitions across the front of the room sound smooth, and that sounds from all speakers appear to arrive at the listening position at the same time (without delay from the center speaker compared to the left and right speakers.)

Surround speakers should be placed on the side walls of the room, at or slightly behind the listening position. The center of the speaker should face into the room. The speakers should be located so that the bottom of the cabinet is at least two feet higher than the listeners' ears when the listeners are seated in the desired area.

If side-wall mounting is not practical, the speakers may be placed on a rear wall, behind the listening position. Again, they should be located so that the bottom of the cabinet is at least two feet higher than the listeners' ears. The speakers should be no more than six feet behind the rear of the seating area.

Subwoofers produce nondirectional sound, so they may be placed almost anywhere in a room. Actual placement should be based on room size and shape and the type of subwoofer used. One method of finding the optimal location for a subwoofer is to begin by placing it in the front of the room, about six inches from a wall, or near the front corner of the room.

Another method is to temporarily place the subwoofer in the spot where you will normally sit, and then walk around the room until you find a spot where the subwoofer sounds best. Place the subwoofer in that spot. You should also follow the instructions of the subwoofer's manufacturer, or you may wish to experiment with the best location for a subwoofer in your listening room.

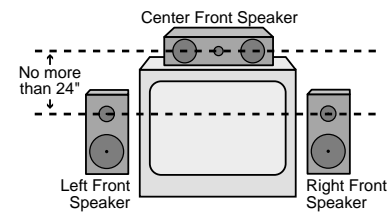

A) Front Channel Speaker Installation with Direct-View TV Sets or Rear-Screen Projectors

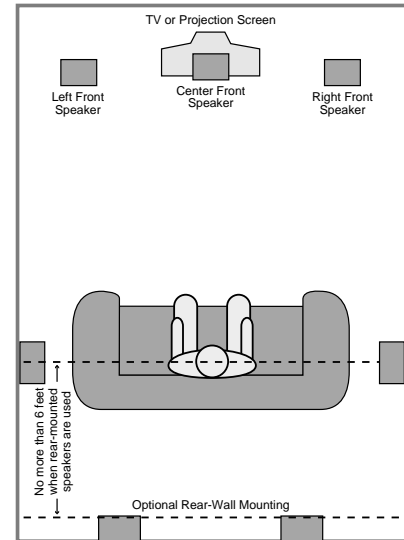

B) The distance between the left and right speakers should be equal to the distance from the seating position to the viewing screen. You may also experiment with placing the left and right speakers slightly forward of the center speaker.

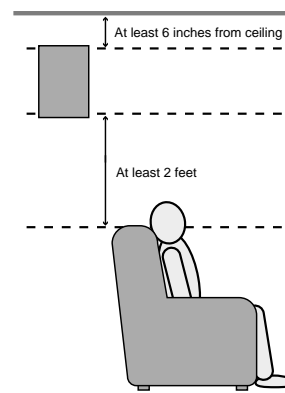

System Configuration

System Setup

Once the speakers have been placed in the room and connected, the remaining steps in the setup process are to program the AVR 500's bass management system for the type of speakers used in your system, calibrate the output levels, and set the delay times used by the surround sound processor.

You are now ready to power up the AVR 500 to begin these final adjustments.

1. Plug the **Power Cable 18** into an unswitched AC outlet.
2. Press the **Main Power Switch 1** in so that it latches in with the word "OFF" appearing on the top of the switch inside the front panel. Note that the **Power Indicator 3** will turn amber, indicating that the unit is in the Standby mode.
3. Install the four supplied AAA batteries in the remote as shown. Be certain to follow the (+) and (-) polarity indicators that are on the bottom of the battery compartment.

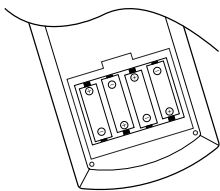

4. Turn the AVR 500 on either by pressing the **System Power Control 2** on the front panel, or via the remote by first pressing the **AVR Selector 1** or any of the CD/Tape/DVD selectors **2** on the remote. The **Power Indicator 3** will turn green to confirm that the unit is on, and the **Information Display 35** will also light up.

Using the On-Screen Display

When making the following adjustments, you may find them easier to make if you use the unit's on-screen display system. These easy-to-read displays give you a clear picture of the current status of the unit and make it easy to see which speaker, delay, input or digital selection you are making.

To view the on-screen displays, make certain you have made a connection from the **TV Monitor Video Out** jack **21** on the rear panel to the composite or S-Video input of your TV or projector. In order to view the AVR's displays, the correct video source must be selected on the video display.

IMPORTANT NOTE: When viewing the displays on a projection TV it is important that they not be left on the screen for an extended period of time. As with any video display, but particularly with projectors, constant display of a static image such as these menus or video-game images may cause the image to be permanently "burned into" the CRT. This type of damage is not covered by the AVR 500 warranty and may not be covered by the projector TV set's warranty.

The AVR 500 has two on-screen display modes, "Semi-OSD" and "Full-OSD." When making configuration adjustments, it is recommended that the Full-OSD mode be used. This will place a complete status report or option listing on the screen, making it easier to view the available options. The Semi-OSD mode uses one-line displays only.

To view the Full-OSD screens, press the OSD button **19** three times. The first press will bring up the Semi-OSD mode and the second press will turn the OSD system off; the third press will call up the Full-OSD display (Figure 1).

When either OSD mode has been selected, a message will appear at the bottom of the screen any time the mode or source is changed. First, the new mode or source will show, and if the source is changed there will also be a confirmation of the mode in use.

Note that the full-screen displays will time-out after 20 seconds. However, the on-screen display used with the channel output level adjustments will remain on the screen as long as the settings are being changed. This display must be manually turned off by pressing the OSD button **19**.

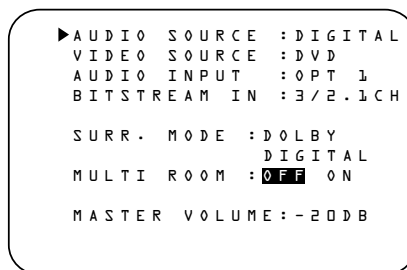

Figure 1

When making most setup adjustments, the full on-screen readout may be displayed at any time by pressing the OSD button **19** once. The displays will remain on the screen as long as adjustments are being made, or for twenty seconds after the last button is pressed to change a setting.

Speaker Configuration

The first few adjustments tell the AVR 500 which type of speakers are in use. This is important as it adjusts the settings that determine which speakers receive low-frequency (bass) information. For each of these settings use the **LARGE** setting if the speakers for a particular position are traditional full-range loudspeakers that are capable of reproducing sounds below 100Hz. Use the **SMALL** setting for smaller, frequency-limited satellite speakers that do not reproduce sounds below 100Hz. Note that when "small" speakers are used, a subwoofer is required to reproduce low-frequency sounds. Remember that the "large" and "small" descriptions do not refer to the actual physical size of the speakers, but their ability to reproduce low-frequency sounds. If you are in doubt as to which category describes your speakers, consult the specifications in the speakers' owner's manual, or ask your dealer.

With the AVR 500 turned on, follow these steps to configure the speakers:

1. Put the AVR 500 in the Dolby Pro Logic mode by pressing the **Dolby Pro Logic Selector 20** on the front panel or by pressing the **Surround Mode Selector 31** on the remote, followed by the **▲/▼** buttons **7** until **PRO LOGIC** appears in the **Main Information Display V** and the **PRO LOGIC** indicator **G** lights.
2. Press the **Speaker** button **30 33** on the remote or front panel. The words **FRNT SPEAKER** will appear in the **Main Information Display V**.

If you are using the on-screen display system, a display will appear indicating the status of each speaker (Figure 2).

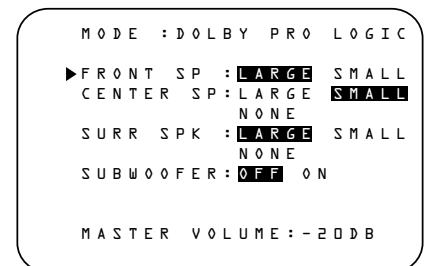

Figure 2

3. Press the **Set** button **9 31** and note that the **▶** pointer will stop flashing.

System Configuration

4. Press the ▲/▼ buttons **7** on the remote or the **Selector** buttons **34** on the front panel until either **LARGE** or **SMALL** appears, matching the type of speakers you have at the left-front and right-front positions, as described by the definitions shown on preceding page.

When **SMALL** is selected, low-frequency sounds will be sent to the subwoofer output only. Note that if you choose this option, and there is no subwoofer connected, you will not hear any low-frequency sounds from the front channels.

When **LARGE** is selected, a full-range output will be sent to the front-left and front-right outputs, and NO low-frequency signals will be sent to the subwoofer output.

NOTE: To use the On-Screen Display system, press the **OSD** button **19** once. The selected speaker option will appear in highlighted video. The selection will change in response to the steps outlined on these pages.

5. When you have completed your selection for the front channel, press the **Set** button **9** **31**, and then press the ▲/▼ buttons **7** on the remote or the **Selector** buttons **34** on the front panel to change the display to **CEN SPEAKER**.

6. Press the **Set** button **9** **31** again, and use the ▲/▼ buttons **7** on the remote, or the **Selector** buttons **34** on the front panel, to select the option that best describes your system based on the speaker definitions shown on preceding page.

When **CEN SP SMALL** is selected, low-frequency center-channel sounds will be sent to the subwoofer output only. Note that if you choose this option and there is no subwoofer connected, you will not hear any low-frequency sounds from the center-channel speaker.

When **CEN SP LARGE** is selected, a full-range output will be sent to the center-speaker output, and NO center channel signal will be sent to the subwoofer output.

When **CEN SP NONE** is selected, no signals will be sent to the center-channel output. The receiver will operate in a "phantom" center-channel mode and

center-channel information will be sent to the left- and right-front channel outputs.

7. When you have completed your selection for the center channel, press the **Set** button **9** **31**, and then press the ▲/▼ buttons **7** on the remote or the **Selector** buttons **34** on the front panel to change the display to **SUR SPEAKER**.

8. Press the **Set** button **9** **31** again, and then use the ▲/▼ buttons **7** on the remote or the **Selector** buttons **34** on the front panel to select the option that best describes your system based on the speaker definitions shown on preceding page.

When **SUR SP SMALL** is selected, low-frequency surround-channel sounds will be sent to the subwoofer output only. Note that if you choose this option and there is no subwoofer connected, you will not hear any low-frequency sounds from the surround speaker.

When **SUR SP LARGE** is selected, a full-range output will be sent to the surround-channel outputs, and NO surround channel signals will be sent to the subwoofer output.

When **SUR SP NONE** is selected, surround-sound information will be split between the front-left and front-right outputs. Note that for optimal performance when no surround speakers are in use, the Dolby 3 Stereo mode should be used instead of Dolby Pro Logic.

9. When you have completed your selection for the surround channel, press the **Set** button **9** **31**, and then press the ▲/▼ buttons **7** on the remote or the **Selector** buttons **34** on the front panel to change the display to **S-W SPEAKER**.

10. Press the **Set** button **9** **31**, and then press the ▲/▼ buttons **7** on the remote or the **Selector** buttons **34** on the front panel to select the option that best describes your system.

Select **S-W SP ON** if a subwoofer is connected to your system.

Select **S-W SP OFF** if a subwoofer is NOT connected to your system. Note that

when no subwoofer is selected, low-frequency sounds below 100Hz will be sent to the front-left and front-right speakers, provided that the selection in Step 4 has been set to **LARGE**. Otherwise, no low-frequency sounds will be heard at all. This option is not available when the front, center or surround speakers are set to **SMALL**.

11. When all speaker selections have been made, press the **Set** button **9** **31** to return to normal operation.

Output Level Adjustment

Output level adjustment is a key part of the configuration process for any surround-sound product. It is particularly important for a Dolby Digital receiver such as the AVR 500, as correct outputs will ensure that you hear sound tracks in their proper place with the proper directionality and intensity.

IMPORTANT NOTE: Listeners are often confused about the operation of the surround channels. While some assume that sound should always be coming from each speaker, most of the time there will be little or no sound in the surround channels. This is because they are only used when a movie director or sound mixer specifically places sound there to create ambiance, a special effect or to continue action from the front of the room to the rear. When the output levels are properly set it is normal for surround speakers to operate only occasionally. Artificially increasing the volume to the rear speakers may destroy the illusion of an enveloping sound field that duplicates the way you hear sound in a movie theater or concert hall.

Before beginning the adjustment process make certain that all speaker connections have been properly made. The system volume should be set to the level that you will use during a typical listening session. Finally, make certain that the **Balance Control** **7** is set to the center "12 o'clock" position.

To adjust and calibrate the output levels, follow these steps. For accurate calibration, it is a good idea to make these adjustments while seated in your favorite listening position:

1. Put the AVR 500 in the Dolby Pro Logic mode by pressing the **Dolby Pro Logic Selector** **20** on the front panel or by pressing the **Surround Mode Selector** **31** on the remote, followed by the ▲/▼

System Configuration

buttons **7** until PRO LOGIC appears in the **Main Information Display V** and the PRO LOGIC indicator **G** lights up.

2. Press the **Test** button **5** on the remote. The words **T-T FL 0dB** will appear in the **Main Information Display V**, and the letters **FL** will flash once each second.

NOTE: To use the on-screen display while making output level adjustments, press the **OSD** button **19**. A map of the installed speakers will appear on your video screen (Figure 3), and the channel where the test noise should be heard will be indicated by the highlighted lettering. As adjustments are made, the numbers under the channel location will increase or decrease to show the change from the reference level.

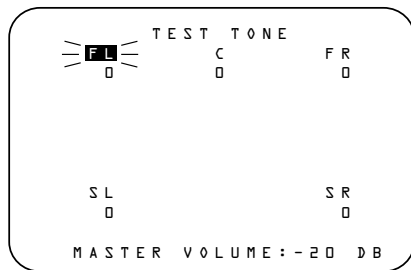

Figure 3

3. At this point, the test noise will begin to circulate among all the speakers in a clockwise rotation.

NOTE: This is a good time to verify that the speakers have been properly connected. As the test noise circulates, listen to make certain that the sound comes from the speaker position shown in the Main Information Display. If the sound from a speaker location does NOT match the position indicated in the display, turn the AVR 500 off using the **Main Power Switch 1** and check the speaker wiring to make certain that each speaker is connected to the correct output terminal.

4. After checking for speaker placement, let the test noise circulate again, and listen to see which channels sound louder than the others. Using the front left (**FL** in the display) speaker as a reference, press the **▲/▼** buttons **7** on the remote or the **Selector** buttons **34** on the front panel on each channel to begin to bring them to the same level. Note that when one of the buttons is pushed, the test noise circulation

will pause on the channel being adjusted to give you time to make the adjustment. When you release the button, the circulation will resume after 20 seconds.

5. Continue to adjust the individual speakers until they all have the same volume. Note that adjustments should be made with the **▲/▼** buttons **7** on the remote or the **Selector** buttons **34** on the front panel only, NOT the main volume controls. Then press the **Set** button **9 31** to memorize the change. If you are using a sound pressure (SPL) meter for precise level adjustment, set the volume so that the meter reads 75dB, C-Weighting Slow.

NOTE: The subwoofer output level is not adjustable using the test tone. To change the subwoofer level, follow the steps for Output Level Trim Adjustment on page 25.

6. When you have adjusted the outputs so that all channels have the same level, press the **Test Tone** button **5** on the remote to complete the adjustment.

Delay Settings

Due the different distances between the front-channel speakers and the listening position compared to the surround speakers and the listening position, the amount of time it takes for sound to reach your ears from the front or surround speakers is different. You may compensate for this difference through the use of the delay settings to adjust the timing to tailor the specific speaker placement and acoustic conditions in your listening room or home theater.

The factory setting is appropriate for most rooms, but some installations create an uncommon distance between the front and surround speakers that may cause the arrival of front-channel sounds to become disconnected from surround-channel sounds.

To resynchronize the front and surround channels, follow these steps:

1. Measure the distance from the listening/viewing position to the front speakers.
2. Measure the distance from the listening/viewing position to the surround speakers.
3. Subtract the distance to the surround speakers from the distance to the front speakers.

a. When setting the delay time for the Dolby Digital surround modes, the optimal delay time is the result of that subtraction. For example, if the front speakers are ten feet away and the surround speakers are five feet away, the optimal delay time is figured as $10-5=5$. Thus, in this example, the delay time for Dolby Digital should be set at five milliseconds.

b. When setting the delay time for the Pro Logic mode, take the result of the subtraction and add 15 to obtain the optimal delay time. For example, if the front speakers are ten feet away and the surround speakers are five feet away, the optimal delay time is figured as $10-5+15=20$. Thus, in this example, the Pro Logic delay should be set at twenty milliseconds.

NOTE: The DTS, Logic 7 and Theater modes use a fixed, nonadjustable delay time.

The Dolby Digital Mode also includes a separate setting for the center-channel delay mode, since the discrete nature of these signals makes the location of the center-channel speaker more critical. To calculate the delay for the center channel, measure the distance from the preferred listening position in the center of the room to both the center-channel speaker and either the left or right speaker.

If the distances are equal, no further adjustment is required and the center delay should be set to zero. If the distance to the front speakers is greater than the distance to the center speaker, you may wish to reposition the speakers by moving the front-left and front-right speakers closer to the listening position or the center speaker further away from the listening position.

If repositioning of the speakers is not possible, adjust the center delay time, adding one millisecond of center-channel delay for every foot closer to the listening position the center speaker is than the front speakers. For example, if the front-left and front-right speakers are each 10 feet from the listening position and the center-channel speaker is 8 feet away, the delay is figured as $10-8=2$, suggesting an optimal center delay of 2 milliseconds.

System Configuration

To set the delay times, follow these steps:

1. Put the AVR 500 in the Dolby Pro Logic mode by pressing the **Dolby Pro Logic Selector** **20** on the front panel or by pressing the **Surround Mode Selector** **31** on the remote, followed by the **▲/▼** buttons **7** until **PRO LOGIC** appears in the **Main Information Display V** and the **PRO LOGIC** indicator **G** lights up.

2. Press the **Delay** button **28 29** on the remote or front panel. The words **S DELAY TIME** will appear in the **Main Information Display V** and at the bottom of a video screen when the Semi-OSD display is in use.

To use the on-screen display system while making delay adjustments, press the **OSD** button **19** until the full-screen menu shown in Figure 4 appears on the screen.

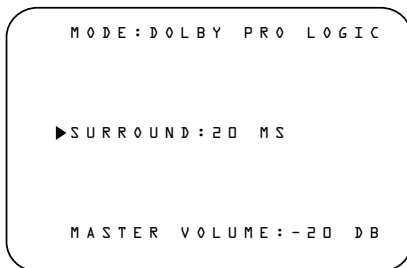

Figure 4

3. Press the **Set** button **9 31**.
4. Adjust the delay time by pressing the **▲/▼** buttons **7** on the remote or the **Selector** buttons **34** on the front panel until the delay time figure calculated using the formula entered above appears in the display.
5. If only analog sources will be used, no adjustment is needed for the center-channel delay. In that case, press the **Set** button **9 31** to enter the surround delay settings into the AVR's memory. However, if you will be using digital sources and the calculations outlined above indicate that the center-channel delay requires an adjustment, continue with the following steps.

6. Before setting the center-channel delay time, make certain that a digital source has been selected. If a digital source is playing, **COAX A** or **OPTICAL C** will appear in the Information display **V**, along with the **DIGITAL** indicator **F**. If a digital source is already connected and playing, press the **Delay** button **29 28** so that the words **C DELAY TIME** appear in the Main Information Display **35** and proceed to step #10. If a digital source is not playing, follow steps 6 through 10.

7. Press the **Set** button **9 31**.

8. Select the Dolby Digital mode either by pressing the front panel **Dolby Digital Selector** **19** or by pressing the **Surround Mode Selector** **31** on the remote, and then pressing the **▲/▼** buttons **7** on the remote until **DOLBY D** appears in the **Main Information Display V** or in the on-screen display. Ignore any "NO DATA" message that may appear.

9. Press the **Delay** button **28 29** on the remote or front panel. The words **S DELAY TIME** appear in the **Main Information Display V**.

10. Press the **▲/▼** buttons **7** on the remote once, so that **C DELAY TIME** appears in the **Main Information Display V** or in the on-screen display.

11. Press the **Set** button **9 31**.

12. Press the **▲/▼** buttons **7** on the remote until the desired delay time for the center channel appears in the display.

13. Press the **Set** button **9 31** to enter the setting into the AVR 500's memory.

You have now completed the setup, adjustment and calibration of the AVR 500. You are now ready to enjoy the finest in music and home theater listening.

Operation

Basic Operation

Once you have completed the setup and configuration of the AVR 500, it is simple to operate and enjoy. The following instructions should be followed for you to maximize your enjoyment of your new receiver:

- When using the AVR 500 for the first time, you must press the **Main Power Switch 1** on the front panel to turn the unit on. This places the unit in a Standby mode, as indicated by the amber color of the **Power Indicator 3**. Once the unit is in Standby, you may begin a listening session by pressing the **System Power Control 2** on the front panel or the **AVR Selector 1** or **CD/TAPE/DVD Input Selector 2**. Note that the **Power Indicator 3** will turn green. This will turn the unit on and return it to the input source that was last used. The unit may also be turned on from Standby by pressing any of the **Source Selector** buttons on the remote **13 14** or front panel **9 10 11 12 13 14**.

To turn the unit off at the end of a listening session, simply press the **System Power Control 2** on the front panel or the **Power Off Button 4** on the remote. Power to any equipment plugged into the rear panel **Switched AC Outlet 16** will be shut off and the **Power Indicator 3** will turn amber.

When the remote is used to turn the unit "off" it is actually placing the system in a Standby mode, as indicated by the amber color of the **Power Indicator 3**.

- To program the AVR 500 for automatic turn-off, press the **Sleep Button 33** on the remote. Each press of the button will increase the time before shut down in the following sequence:

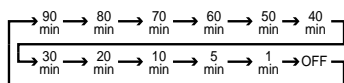

The sleep time will be displayed in the Information Display and it will count down until the time has elapsed.

When the programmed time has elapsed, the unit will automatically turn off. Note that the front-panel display will dim to one-half brightness when the Sleep function is programmed. To cancel the Sleep function, press and hold the **Sleep Button 33** until the information display returns to normal brightness and the Sleep indicator numbers disappear.

When you will be away from home for an extended period of time it is always a good idea to completely turn the unit off using the front panel **Main Power Switch 1**.

NOTE: All preset memories are lost if the unit is left turned off with the **Main Power Switch 1** for more than two weeks.

Using the On-Screen Display

The AVR 500 is equipped with a powerful on-screen display system that makes it easy to view the current status of the unit or to have messages appear to confirm any functional change, such as a volume increase, input source selection, or surround-mode selection. Two modes of on-screen display are available, a "Semi-OSD" mode that only displays a message when some aspect of the operation is changed, and a "Full-OSD" mode that displays a complete status report on the unit's current condition.

Semi-OSD

In the Semi-OSD mode, a one-line message will appear at the bottom of the screen when changes are made to the unit's operational status. To activate the Semi-OSD mode, press the **OSD button 19** once. A confirmation message (Figure 5) will appear briefly at the bottom of your video display to remind you that this feature is turned on. The message will time-out and disappear after a few seconds.

When Semi-OSD mode is in use, single-line messages will appear at the bottom of the screen to confirm changes to the volume, source, surround mode or tuner frequency. These messages, which will also be superimposed on any video program that is playing, will disappear after a few seconds.

To turn off the Semi-OSD mode after it has been activated, simply press the **OSD button 19** once. When the **OSD OFF** message appears, the on-screen displays are deactivated.

Full-OSD

An alternative display option is to have a full-screen report of the AVR 500's status appear. To activate the Full-OSD, press the **OSD button 19** three times in quick succession. The first press will turn the Semi-OSD on, the second will turn the Semi-OSD off, and the third will bring a full-status report to the screen. **NOTE:** Full-OSD displays will always appear against a blue background. Even if video is playing, they will not be superimposed over the signal. To

view OSD items and video at the same time you must use the Semi-OSD mode.

The status report will vary depending on the type of audio input in use. For an analog source, the first line in the display will show which audio input is active (Figure 5). When a digital audio source is in use, the display will indicate which coaxial or optical input is active (Figure 6).

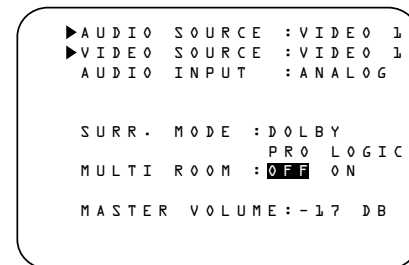

Figure 5

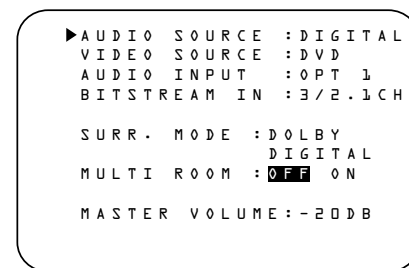

Figure 6

Activating the Full-OSD will also simplify adjustments to any system parameter, as a full list of choices will be shown. The selected option will appear in reversed, highlighted video, while other choices will appear in normal white on blue video.

The Full-OSD system may be turned off by pressing the **OSD button 19** once.

Display Brightness

In the normal, factory default setting, the front panel **Information Display 35** will always illuminate at full brightness. However, in some installations you may prefer to have the display appear at half brightness or not illuminate at all. To adjust the setting so that the display lights at other than full brightness, follow these steps:

- Press both **◀/▶ Selector Buttons 34** at the same time. Note that **VFD DIMMER** will appear in the Main Information Display **V**.
- Quickly release both buttons, and then press and release the **Set Button 31**. The

Operation

Main Information Display **V** will now read **VFD FULL**.

- Within five seconds, press either of the **◀/▶ Selector Buttons 34** to choose either half brightness, as indicated by the display **VFD HALF**, or completely off with the display blank. You may cycle through all of the options by continually pressing the **◀/▶ Selector Buttons 34**.
- When the desired brightness setting is reached, Press **Set Button 31** twice to return to normal.

Source Selection

- To select a source at any time, press any of the **Source Selector** buttons on the remote **2 13 14** or front panel **9 10 11 12 13 14**.
- The front-panel **Video 3 Inputs 8** may be used to connect a device such as a video game or camcorder to your home entertainment system on a temporary basis.
- When an audio source is selected the last video input used remains routed to the **Video Outputs 1 2** and **TV Monitor Video Output 21**. This permits simultaneously viewing and listening to different sources.
- When a Video Input source is selected, the video signal for that input will be routed to the **TV Monitor Video Output** jack **21** and will be viewable on a TV monitor connected to the AVR 500. Make certain that your TV is set to the proper input to view the signal.

Volume Control

- Adjust the volume to a comfortable level using the front-panel **Volume Control 28** or remote **Volume Up/Down 32** buttons.
- When listening in the Stereo mode, with the surround circuits off, the **Balance Control 7** may be used to adjust the relative sound output between the left-front and right-front speakers.
- To temporarily silence all speaker outputs press the **Mute button 6 27**. This will interrupt the output to all speakers and the headphone jack, but it will not affect any recording or dubbing that may be in progress. When the system is muted the **MUTE** indicator **X** will light in the **Information Display 35**. Press

the **Mute button 6 27** again to return to normal operation.

- During a listening session you may wish to adjust the **Bass Control 5** and **Treble Control 6** to suit your listening tastes or room acoustics.
- For private listening, plug the 1/4" stereo phone plug from a pair of stereo headphones into the front-panel **Headphone Jack 4**.
- In normal operation, when the AVR 500 is turned on, it will always return to the volume setting in effect when the unit was turned off. However, for some installations you may prefer to always have the AVR turn on at a specific setting, regardless of the level when the unit was turned off. To enter that mode and setting, follow these steps:

1. Press both of the **◀/▶ Selector Buttons 34** at the same time. Note that **VFD DIMMER** will appear in the **Main Information Display V**.
2. Quickly release both buttons, and then press either one of the **◀/▶ Selector Buttons 34** again and note that **VOL DEFAULT** will appear in the **Main Information Display V**.
3. To have the volume control *always* turn on at the same level, press the **Set Button 9** and then release it. The Main Information Display will now read **Vol Set - xxDB**, with the actual number being the current volume level.
4. Within five seconds, use the Volume Control **28** to set the desired volume level for turn on.
5. When the volume level is set, press the **Set Button 9 31** twice to return to normal operation.

- To return the Volume Control setting at turn on to the last volume level in use, follow these steps:

1. Press both of the **◀/▶ Selector Buttons 34** at the same time. Note that **VFD DIMMER** will appear in the **Main Information Display V**.
2. Quickly release both buttons, and then press either one of the **◀/▶ Selector**

Buttons **34** again and note that **VOL DEFAULT** will appear in the **Main Information Display V**.

3. Press the **Set Button 9 31**.
4. Press the **◀/▶ Selector Buttons 34** until **DEFAULT OFF** appears in the **Main Information Display V**.
5. Press the **Set Button 9 31** twice to return to normal operation.

Surround-Mode Selection

One of the most important features of the AVR 500 is its ability to reproduce a full multi-channel surround-sound field from digital sources, analog matrix surround-encoded programs and standard stereo programs. In all, a total of eight listening modes are available on the AVR 500.

Selection of a surround mode is based on personal taste, as well as the type of program source material being used. For example, motion pictures or TV programs bearing the logo of one of the major surround-encoding processes, such as Dolby Surround, DTS Stereo or UltraStereo[†] may be played in either the Dolby Digital, Dolby Pro Logic or Movie Surround modes depending on the source material.

NOTE: Once a program has been encoded with surround information, it retains the surround matrix as long as the program is broadcast in stereo. Thus, movies with surround sound will carry surround information when they are broadcast via conventional TV stations, cable, pay TV and satellite transmission. In addition, a growing number of made-for-television programs, sports broadcasts, radio dramas and music CDs are also recorded in surround sound. You may view a list of these programs at the Dolby Laboratories Web site at www.dolby.com.

When a program is not listed as carrying intentional surround information, you may find that the Pro Logic, Dolby 3 Stereo, Logic 7 and VMAx modes often deliver enveloping surround presentations through the use of the natural information present in all stereo recordings. However, for stereo, but non-surround programs, we suggest that you try the Logic 7, VAMx or Theater modes.

Surround modes are selected using either the front-panel controls or the remote. To select a surround mode from the front panel, simply press the button that corresponds to the

(continued on page 23)

Operation

Surround Mode Chart

MODE	FEATURES	DELAY TIME RANGE
DOLBY DIGITAL	Available only with digital input sources encoded with Dolby Digital data. It provides up to five separate main audio channels and a special dedicated Low-Frequency Effects channel.	Center: 0 ms – 5 ms Surround: 0 ms – 15 ms
DTS	Available only with digital input sources encoded with DTS data. Available on special DVD, LD and audio-only discs, DTS provides up to five separate main audio channels and a special dedicated low-frequency channel.	Delay not adjustable
DOLBY PRO LOGIC	The standard mode for analog surround sound decoding. It uses information encoded in a two-channel stereo recording to produce four distinct outputs: Left, Center, Right and a Mono Surround channel. Use this mode for accurate reproduction of programs bearing the Dolby Surround, DTS Stereo, UltraStereo or other "Surround" logos. Surround-encoded programs include videocassette, DVD and LD movies, TV and cable programs, radio programs and audio CDs. Dolby Pro Logic processing may also be used to provide a pleasing surround effect with some stereophonic source material that does not carry surround encoding.	15 ms – 30 ms Initial Setting = 20 ms
LOGIC 7 C LOGIC 7 M	An advanced mode that extracts the maximum surround information from either surround-encoded programs or conventional stereo material. When used with encoded material, decoding is more accurate in terms of the placement of sounds, and fades and pans are much smoother and more realistic than with other decoding techniques. Logic 7 also delivers increased spaciousness and a wider sound stage when it is used with conventional stereo recordings and music programs. The Logic 7C or Cinema mode is tailored to provide an optimal sound field for movie soundtracks. The Logic 7M or Music mode uses a decoding formula that is best suited to music.	Delay time not adjustable
DOLBY 3 STEREO	Uses the information contained in a surround-encoded or two-channel stereo program to create center-channel information. In addition, the information that is normally sent to the rear-channel surround speakers is carefully mixed in with the front-left and front-right channels for increased realism. Use this mode when you have a center-channel speaker but no surround speakers.	No surround channels
THEATER	Surround processing uses matrix surround decoding to simulate a standard movie or stage theater.	27.3 ms (not adjustable)
VMAx	When only the two front-channel loudspeakers are used, Harman's patented VMAx mode delivers a three-dimensional sound space with the illusion of "phantom speakers" at the center and surround positions.	No surround channels
STEREO	This mode turns off all surround processing and presents the pure left and right channel presentation of two-channel stereo programs.	No surround channels

Operation

(continued from page 21)

desired mode **19 20 21 22 23 24**. To select a surround mode using the remote, press the **Surround Mode Selector 31**, and then press the **▲/▼** buttons **7** to change the mode. As you press the buttons, the Surround mode name will appear in the **Main Information Display V**, and an individual mode indicator will also light up **F G H I J K**.

Note that the Dolby Digital or DTS modes may only be selected when a digital input is in use. For more information on selecting digital sources, see the following section of this manual.

To listen to a program in traditional two-channel stereo, using the front-left and front-right speakers only (plus the subwoofer if installed and configured), press the **Surround Off** button **26** on the front panel, or follow the instructions shown above for using the remote until **SURR OFF** appears in the **Main Information Display V**. When the AVR 500's surround circuits are turned off, and it is in the Stereo mode, the **SURR OFF** indicator **L** will illuminate in the **Information Display 35**.

Digital Audio Playback

Digital audio such as Dolby Pro Logic is a major advancement over past systems. It delivers five discrete channels: left front, center, right front, left surround and right surround. Each channel is full range and offers dramatically improved dynamic range and significant improvements to signal-to-noise ratios. In addition, both of the digital systems have the capability to deliver an additional channel that is specifically devoted to low-frequency information. This is the ".1" channel referred to when you see these systems described as "5.1". The bass channel is totally separate but since it is intentionally bandwidth limited, sound designers have given it that unique designation.

Dolby Digital

Dolby Digital (originally known as AC-3[®]) is available on DVD and LD discs and is a part of the new high-definition television (HDTV) system.

Note that an optional, external RF demodulator is required to use the AVR 500 to listen to the Dolby Digital sound tracks available on laser discs. Connect the RF output of the LD player to the demodulator and then connect the digital output of the demodulator to the the **Optical** or **Coaxial** inputs **23 24** of the AVR 500. No

demodulator is required for use with DTS-encoded laser discs.

DTS

DTS is another digital audio system that is capable of delivering 5.1 audio. Although both DTS and Dolby Digital are digital, they use different methods of encoding the signals, and thus they require different decoding circuits to convert the digital signals back to analog.

DTS-encoded soundtracks are available on select DVD and LD discs, as well as on special audio-only DTS discs. You may use any LD or CD player equipped with a digital output to play DTS-encoded discs with the AVR 500. All that is required is to connect the player's output to either the **Optical** or **Coaxial** input on the rear panel **23 24**.

In order to listen to DVDs encoded with DTS sound track, the DVD player must be compatible with the DTS signal as indicated by a DTS logo on the player's front panel. Note that early DVD players may not be able to play DTS-encoded DVDs. This does not indicate a problem with the AVR 500, as some players cannot pass the DTS signal through to the digital outputs. If you are in doubt as to the capability of your DVD player to handle DTS discs, consult the player's owner's manual.

Selecting a Digital Source

To utilize either digital mode you must have a digital source properly connected to the AVR 500. Connect the digital outputs from DVD players, HDTV receivers and CD players to the **Optical** or **Coaxial** inputs on the rear panel **23 24**. In order to provide a backup signal and a source for analog stereo recording, the analog outputs provided on digital source equipment should also be connected to their appropriate inputs on the AVR 500 rear panel (e.g., connect the analog stereo audio output from a DVD to the **DVD** inputs **5** on the rear panel when you connect the source's digital outputs).

When playing a digital source such as DVD, first select the input using the remote or front-panel controls as outlined in this manual. Next, select the digital source by pressing the appropriate **Digital Input Selector** button **30** and then using the **▲/▼** buttons **7** on the remote or the **Selector** buttons **34** on the front panel to choose either of the two **OPTICAL** or **COAXIAL** inputs, as they appear in the **Main Information Display V** or on-screen display. Press the **Set** button **9 31** to enter

the desired choice. When the digital source is playing, the AVR 500 will automatically detect whether it is a multichannel Dolby Digital or DTS source, or a conventional PCM signal, which is the standard output from CD players. An indicator will light in the **Information Display** to confirm the digital signal is **Dolby Digital F** or **PCM E** and if the source is **OPTICAL C** or **COAX A**.

Digital Status

When a digital source is playing, the AVR 500 will automatically switch to the proper surround mode. It is important to note, however, that not all Dolby Digital or DTS sources are encoded with the full complement of five channels plus LFE. When a digital source is playing, the **Main Information Display V** or on-screen display will change to show the input source and digital type (**OPTICAL** or **COAX**). When a source with digital encoding is playing, the input source name will appear in the **Information Display** or on-screen display, followed by a numeric key indicating the type and number of channels being decoded as follows:

3/2.1: This message appears when a full complement of Dolby Digital signals is present: 3 front channels (left, center and right), 2 surround channels (surround left and surround right) and "1" channel, which is the dedicated Low Frequency Effects (LFE) channel.

3/1: This message indicates the system is decoding a standard Dolby Pro Logic signal with left-front, center and right-front channels and a single mono surround channel.

2/0: This message indicates that the system is decoding a traditional two-channel stereo signal and that no center, surround or LFE signals are present.

1/0: This is a monaural signal that plays through the center-channel speaker only. There is no sound at the front-left, front-right or surround speakers.

The current status of the AVR may also be obtained by pressing the **OSD Button 19** until the Full-OSD appears on your video display's screen.

Night Mode

A special feature of Dolby Digital is the Night mode, which enables AC-3 input sources to be

Operation

played back with full digital intelligibility while reducing the minimum peak level by 1/4 to 1/3. This prevents abruptly loud transitions from disturbing others without reducing the impact of the digital source. The Night mode is available only when Dolby Digital signals with special data are being played.

To engage the Night mode, press the **Night** button **26** on the remote and note that the **NI** mode indicator **N** will illuminate in the Information Display and a message will appear on the OSD.

IMPORTANT NOTES ON DIGITAL PLAYBACK:

1. When the digital playback source is stopped, or in a pause, fast forward or chapter search mode, the digital audio data will momentarily stop, causing a **NO DATA** message to be displayed in the **Main Information Display V** or on-screen display. This is normal and does not indicate a problem with either the AVR 500 or the source machine. The AVR 500 will return to digital playback as soon as the data is available and when the machine is in a standard play mode.

2. Although the AVR 500 will decode virtually all DVD movies, CDs and HDTV sources, it is possible that some future digital sources may not be compatible with the AVR 500.

3. Note that not all digitally encoded programs contain full 5.1 channel audio. Consult the program guide that accompanies the DVD or laser disc to determine which type of audio has been recorded on the disc. The AVR 500 will automatically sense the type of digital surround encoding used and adjust to accommodate it.

4. When a digital source is playing, you may not select any of the analog surround modes such as Dolby Pro Logic, Dolby 3 Stereo or Theater or Logic 7.

5. When a Dolby Digital or DTS source is playing, it is not possible to make an analog recording using the Tape **26** and VCR 1 **2** record outputs. However, the digital signals will be passed through to the digital audio outputs **9**.

PCM Audio Playback

PCM (Pulse Code Modulation) is the non-compressed digital audio system used for compact discs and Dolby Digital or DTS laser

discs. The digital circuits in the AVR 500 are capable of high-quality digital-to-analog decoding, and they may be connected directly to the digital audio output of your CD or LD player.

Connections may be made to either the **Optical** or **Coaxial** inputs **23** **24** on the rear panel.

To listen to a PCM digital source, first select the input for the desired source (e.g., CD). Next press the **Digital Select** button **30** **11** and then use the **▲/▼** buttons **7** on the remote or the **Selector** buttons **34** on the front panel until the desired choice of either **OPTICAL** or **COAX** appears in the **Main Information Display V**. Press the **Set** button **9** **31** to enter the desired choice.

When a PCM source is playing, the **PCM** indicator **E** will light, and the Main Information Display will show the input source and the digital type. During PCM playback you may select any surround mode except Dolby Digital. When an audio-only DTS disc is played, the AVR will automatically select the DTS mode, and no other mode may be selected.

Tuner Operation

The AVR 500's tuner is capable of tuning AM, FM and FM Stereo broadcast stations. Stations may be tuned manually, or they may be stored as favorite station presets and recalled from a 30-position memory.

Station Selection

1. Press the **AM/FM** button **14** **14** to select the tuner as an input.
2. Press the **AM/FM** button **14** **14** again to switch between AM and FM so that the desired frequency band is selected.
3. Press the **Tune Mode** button **18** **15** to select manual or automatic tuning.

When the **AUTO** indicator **R** is illuminated in the Main Information Display the tuner will only stop at those stations that have a strong enough signal to be received with acceptable quality.

When the **MONO** indicator **S** is illuminated, the tuner is in a manual mode and will stop at each frequency increment in the selected band.

4. To select stations press the **Tuning** button **15** **24**. When the **AUTO** indicator **R** is

illuminated, press the buttons for two seconds and then release to cause the tuner to search for the next highest or lowest frequency station that has an acceptable signal. When tuning FM stations in the Auto mode, the tuner will only select Stereo stations. To tune to the next station, press the button again. If the **MONO** indicator **S** is illuminated, tap the **Tuning** button **15** **24** to advance one frequency increment at a time, or press and hold it to locate a specific station. When the **TUNED** indicator **U** illuminates, the station is properly tuned and should be heard with clarity.

5. Stations may also be tuned directly by pressing the **Direct** button **21**, and then pressing the **Numeric Keys** **17** that correspond to the station's frequency. The desired station will automatically be tuned.

NOTE: When the FM reception of a station is weak, audio quality will be increased by switching to Mono mode by pressing the **Tune Mode** button **18** **15** until the **STEREO** indicator **T** goes out.

Preset Tuning

Up to 30 stations may be stored in the AVR 500's memory for easy recall using the front-panel controls or the remote.

To enter a station to the memory, first tune the station using the steps outlined above; then:

1. Press the **Memory** button **16** on the remote. Note that **MEMORY** indicator **Q** will illuminate and flash in the Information Display.
2. Within five seconds, press the **Numeric Keys** **17** corresponding to the location where you wish to store this station's frequency.
3. Repeat the process after tuning any additional stations to be preset.

Recalling Preset Stations

- To manually select a station previously entered in the preset memory, press the **Numeric Keys** **17** that correspond to the desired station's memory location.
- To manually tune through the list of stored preset stations one by one, press the **Preset** buttons **17** **23** on the front panel or remote.
- To automatically scan through the stations entered in the preset memory, press the **Preset Scan** button **16** on the front panel.

Operation

The tuner will run through the list of preset stations, stopping for five seconds at each one. Press the button again to stop the scan at your desired station.

- To view a list of the stations entered in the preset memory, press the **OSD** button **19** to bring up the Full-OSD screen while the tuner is in use and then press the **Memory** button **16**. The video display screen will show the first 16 stations that have been preset, as shown in Figure 7.

MEMORY TABLE	
1 : FM 102.70	2 : FM 94.70
3 : AM 1070	4 : AM 1130
5 : FM 89.90	6 : FM 91.50
7 : FM 95.50	8 : FM 106.70
9 : AM 790	10 : AM 1150
11 : FM 105.30	12 : FM 101.10
13 : AM 640	14 : AM 1110
15 : FM 98.70	16 : NONE

Figure 7

The word NONE simply indicates that no station information has been entered and that the memory slot is available. To view the remaining stations, press the **Numeric Keys** **17** for a preset number not on the list, and the display will change.

Tape Recording

In normal operation, the audio or video source selected for listening through the AVR 500 is sent to the record outputs. This means that any program you are watching or listening to may be recorded simply by placing machines connected to the outputs for **Tape Out** **25** or **Video 1** **2** in the record mode.

When a digital audio recorder is connected to the digital outputs **9**, you are able to record the digital signal to a CD-R, MiniDisc or other digital recording system.

NOTES:

- The digital outputs are active only when a digital signal is present, and they do not convert an analog input to a digital signal, or change the format of the digital signal. In addition, the digital recorder must be compatible with the output signal. For example, the PCM digital input from a CD player may be recorded on a CD-R or MiniDisc, but Dolby Digital or DTS signals may not.

- Please make certain that you are aware of any copyright restrictions on any material you copy. Unauthorized duplication of copyrighted materials is prohibited by Federal law.

Output-Level Trim Adjustment

Normal output-level adjustment for the AVR 500 is established using the Test Tone, as outlined on page 18. In some cases, however, it may be desirable to adjust the output levels using program material such as a test disc, or a selection you are familiar with. Additionally, the output level for the subwoofer can only be adjusted using this procedure.

To adjust the output levels using program material, first set the reference volume for the front-left and front-right channels using the **Volume Control** **28** **32**. If you wish to vary the difference between the left and right channels, use the **Balance Control** **7**.

Once the reference level has been set, press the **Channel Select** button **8** and note that **FRONT L LEV** will appear in the **Main Information Display** **V**. To change the level, first press the **Set** button **9** **31**, and then use the **Selector** buttons **34** or the **▲/▼** buttons **7** to raise or lower the level. DO NOT use the volume control, as this will alter the reference setting.

Adjusting the output-level trim is easier when the Full-OSD system is used. To do this, first press the **Channel Select** Button **8** and then press the OSD button so that the display shows all available speaker positions as shown in Figure 8. Note that there will be a flashing pointer under the **FL**, or front-left position. When the **Set** button **9** is pressed to start adjustments, the pointer will stop flashing. During adjustments the numbers will increase or decrease to indicate the change from the reference-level setting.

MODE :	DOLBY	PRO	LOGIC
FL	C	FR	
▲			
	S - W		
SL		SR	
MASTER VOLUME : -20DB			

Figure 8

Once the change has been made, press the **Set** button **9** **31** and then press the **Selector** buttons **34** or the **▲/▼** buttons **7** to select the next output channel location that you wish to adjust. To adjust the subwoofer level, press the **Selector** buttons **34** or the **▲/▼** buttons **7** until **S - W OFFER LEV** appears in the **Main Information Display** **V**.

Press the **Set** button **9** **31** when the name of the desired channel appears in the **Main Information Display** **V**, and follow the instructions shown earlier to adjust the level.

Repeat the procedure as needed until all channels requiring adjustment have been set. When all adjustments have been made and no further adjustments are made for twenty seconds, the AVR 500 will return to normal operation.

NOTE: The output levels may be separately trimmed for each digital and analog surround mode. If you wish to have different trim levels for a specific mode, select that mode using the front panel buttons **19** **20** **21** **22** **23** **24** or **31** on the remote control and follow the instructions in the steps shown above.

6-Channel Direct Input

The AVR 500 is equipped for future expansion through the use of optional, external adapters for formats that the AVR 500 may not be capable of processing. When an adapter is connected to the **6-Channel Direct Input** **6**, you may select it by pressing the **6-Ch Input Selector** **12** **13**.

Note that when the 6-Channel Direct Input is in use, you may not select a surround mode, as the external decoder determines processing. In addition, there is no signal at the record outputs when the 6-Channel Direct Input is in use.

Memory Backup

This product is equipped with a memory backup system that preserves tuner presets and system configuration information if the unit is accidentally unplugged or subjected to a power outage. This memory will last for approximately two weeks, after which time all information must be reentered.

Multiroom Operation

The AVR500 is fully equipped to operate as the control center for a sophisticated multi-room operation with optional remote external InfraRed (IR) sensors, speakers and power amplifiers. Although some multi-room installations will require the services of a specially trained installer, it is possible for the average do-it-yourself hobbyist to install a simple remote room system.

Installation

The key to remote room operation is to link the remote room to the AVR500's location with wire for an infrared receiver and speakers or an amplifier. For complete installation instructions for Multiroom use, see page 14.

Multiroom Setup

Once the audio and IR link connections have been made, the AVR500 needs to be configured for multiroom operation using the steps below. When making these selections, you may use the front-panel Information Display, or use the On-Screen Display System. Either the Semi-OSD system may be used, in which case the choices will appear as a single-line display at the bottom of the screen, or the full-screen display may be used. When the Full-OSD display system is in use, the complete list of choices will appear on the screen.

To activate the Semi-OSD, press the **OSD** button **19** once. To activate the Full-OSD, press the **OSD** button **19** three times. This will turn the Semi-OSD on and then off. The Full-OSD will appear after the third button press.

Once you have determined which, if any, OSD system to use, setup and operation of the multiroom system is simple.

1. Press the **Multi** button **27** to initiate the multiroom system. If the Semi-OSD system is engaged, a message will appear at the bottom of the screen. If the Full-OSD system is engaged, the complete multiroom menu (Figure 9) will be shown on the video display. Press the **Set** button **9** within twenty seconds to enter the multiroom menus.

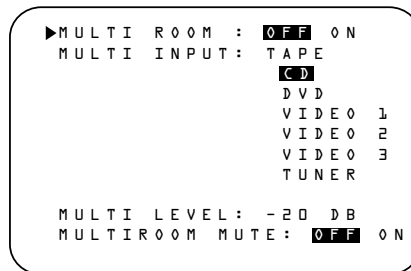

Figure 9

2. Press the **▲** or **▼** buttons **7** to turn the multiroom system on or off, as indicated by the front-panel Information Display message, the Semi-OSD message, or the change in the highlighted video in the Full-OSD screen. Press the **Set** button **9** to enter the settings.
3. Press the **▼** Button **7** to move to the input settings. Press the **Set** button **9** to change the input source. Press the **▲/▼** buttons **7** to select the desired input. When the input source you wish to send to the remote room location appears on the front-panel Information Display, in the lower screen Semi-OSD message, or is highlighted in reverse video in the Full-OSD listing, press the **Set** button **9** to enter the selection.
4. Press the **▼** Button **7** to move to the multilevel setting. Press the **Set** button **9** if you wish to change the output level. Within twenty seconds, press the **▲** or **▼** buttons **7** to change the output level for the multiroom feed. The volume change will appear as a number in dB increments below the 0dB reference level in the front-panel Information Display, as a lower third Semi-OSD message, or as the last line in the Full-OSD status display.
5. Press the **Set** button **9** to enter the setting. If no further buttons are pressed within five seconds, the unit will return to normal operation.

Multiroom Operation

To activate the feed to the remote room, press the **Multi** button **27** on the remote. Next, press the **Set** button **9**. Press the **▲/▼** buttons **7** to turn the multiroom feed on or off. When the multiroom system is on, the **MULTI** indicator **M** will light in the **Information Display 35**, and the **Main Information Display 35** or OSD will display **MULTIROOM ON**. Press the **Set** button **9** to enter the setting.

When the multiroom system is turned on, the previously selected input will be fed to the **Multi Out** jacks **8** on the rear panel. The volume will be as set in the previous selection, although it may also be adjusted using an optional volume control in the remote location or on the optional audio power amplifier connected to the **Multi Out** jacks **8**.

If an optional IR sensor is located in the remote room and connected to the AVR500's Multi IR jack **1**, the multiroom system may be turned on or controlled by simply pointing the AVR500 remote, or an optional programmable remote that includes codes for the AVR500, at the IR sensor. Note that depending on the type of programmable remote used, the code for the AVR's Multi button may not be contained in the preprogrammed code library, and must be "learned" into the remote, if possible.

To change the input source for the multiroom feed once it has been turned on, follow the instructions on this page.

Once the multiroom system is turned on, it will remain on even if the AVR500 is placed in the Standby mode in the main room by pressing the **Power Off** Button **4** or the **System Power Control 2** on the front panel. To turn off the multiroom system, even when the AVR is in Standby mode in the main listening room, press the **Multi** button **27** and then the **Set** button **9**. Press the **▲/▼** buttons **7** so that the **MULTI** indicator **M** in the **Information Display 35** goes out, and the **Main Information Display 35** or OSD will display **MULTIROOM OFF**. Press the **Set** button **9** to enter the setting and turn the unit off.

Even when the AVR is turned off in the main room, the multiroom system may be turned on at any time by pressing the **Multi** button **27**.

Programming the Remote

The AVR 500 is equipped with a powerful remote control that will control not only the receiver's functions, but also most CD players and cassette decks manufactured by Harman Kardon. For increased flexibility, the remote also contains the codes for most popular brands of audio and video equipment, including CD players, cassette decks, TV sets, cable boxes, VCRs, satellite receivers and other home-theater equipment. Once the AVR 500's remote is programmed with the codes for the products you own, it is possible to eliminate most other remotes and replace them with the convenience of a single, backlit universal remote control.

Programming the Remote

As shipped from the factory, the remote is fully programmed for all AVR 500 functions, as well as those of most Harman Kardon CD changers, CD players and cassette decks. In addition, by following one of the methods below, you may program the remote to operate a wide range of devices from other manufacturers.

Direct Code Entry

This method is the easiest way to program your remote to work with different products.

1. Use the tables in the following pages to determine the three-digit code or codes that match both the product type (e.g., VCR, TV), and the specific brand name. If there is more than one number for a brand, make note of the different choices.
2. Turn on the unit you wish to program into the AVR 500 remote.
3. Press and hold both the **Input or Remote Selector** **2** **3** for the type of product to be entered (e.g., VCR, TV) and the **Mute** button **6** at the same time. Hold both buttons until the red light under the Selector button stays lit. Note that the next step must take place while the red light is on, and it must begin within 20 seconds after the light illuminates.
4. Point the AVR 500's remote towards the unit to be programmed, and enter the first three-digit code number using the **Numeric** buttons **17**. If the unit turns off, the correct code has been entered. Press the **Input or Remote Selector** **2** **3** again, and note that the red light will flash twice before going dark to confirm the entry.
5. If the device to be programmed in does NOT turn off, continue to enter the three-digit

code numbers until the equipment turns off. At this point, the correct code has been entered. Press the **Input or Remote Selector** **2** **3** again and note that the red light will flash twice before going dark to confirm the entry.

6. Try all of the functions on the remote to make certain that the product operates properly. Keep in mind that many manufacturers use a number of different combinations of codes, so it is a good idea to make certain that not only does the Power control work, but that the volume, channel and transport controls work as they should. If functions do not work properly, you may need to use a different remote code.
7. If a code cannot be entered to turn the unit off, if the code for your product does not appear in the tables in this manual, or if not all functions operate properly, try programming the remote with the Auto Search Method.

Auto Search Method

If the unit you wish to include in the AVR 500's remote is not listed in the code tables in this manual or if the code does not seem to operate properly, you may wish to program the correct code using the Auto Search method that follows:

1. Turn on the unit that you wish to include in the AVR 500 remote.
2. Press the **Input or Remote Selector** **2** **3** for the type of product to be entered (e.g., VCR, TV) and the **Mute** button **6** at the same time. Hold both buttons until the red light under the button stays lit. Note that the next step must take place while the red light is on, and it must begin within 20 seconds after the light illuminates.
3. Point the AVR 500 remote towards the unit to be programmed, and press and hold the **Surround Mode Selector** **31** or the **Sleep** button **33**. This will send out a series of codes from the remote's built-in data base, with each flash of the red light under the **Input or Remote Selector** **2** **3** indicating that a code has been sent. When the device to be programmed turns off, IMMEDIATELY release the **Surround Mode** or **Sleep** button.
4. Press the **Input or Remote Selector** **2** **3** again, and note that the red light will flash twice before going dark to confirm the entry.

5. Try all of the functions on the remote to make certain that the product operates. Keep in mind that many manufacturers use a number of different combinations of codes, and it is a good idea to make certain that that not only the Power control works, but the volume, channel and transport controls, as appropriate. If all functions do not work properly, you may need to Auto-Search for a different code, or enter a code via the Direct Code Entry method.

Code Readout

When the code has been entered using the Auto Search method, it is always a good idea to find out the exact code so that it may be easily reentered if necessary. You may also read the codes to verify which device has been programmed to a specific Control Selector button.

1. Press and hold both the **Input or Remote Selector** **2** **3** for the type of product to be entered (e.g., VCR, TV) and the **Mute** button **6** at the same time. Hold both buttons until the red light under the button stays lit. Note that the next step must take place while the red light is on, and it must begin within 20 seconds after the light illuminates.
2. Press the **Delay** button **11**. The red light under the **Input or Remote Selector** **2** **3** will blink in a sequence that corresponds to the three-digit code, with a one-second pause between each digit. Count the number of blinks between each pause to determine the digit of the code. One blink is the number 1, two blinks is the number 2, and so forth. Ten blinks are used to indicate a "0".

Example: One blink, followed by a one-second pause, followed by six blinks, followed by a one-second pause, followed by ten blinks indicates that the code has been set to 160.

For future reference enter the Setup Codes for the equipment in your system here:

CD _____ TAPE _____
AUX _____ SAT _____
TV _____ VCR _____
CBL _____ DVD _____

Programming the Remote

Programmed Device Functions

Once the AVR 500's remote has been programmed for the codes of other devices, press the appropriate **Input or Remote Selector** ② ③ to change the remote from control over the AVR 500 to the additional product. When you press any of the **Input or Remote Selectors**, it will briefly flash in red to indicate that you have changed the device being controlled.

When operating a device other than the AVR 500, the controls may not correspond exactly to the function printed on the remote or button. Some commands, such as the volume control, are the same as they are with the AVR 500. Other buttons will change their function so that they correspond to a secondary label on the remote. For example, the Sleep and Surround Mode selector buttons also function as the Channel Up and Channel Down buttons when operating most TV sets, VCRs or cable boxes. The Channel Up/Down indication is printed directly on the remote. The same is true for standard CD player, cassette deck, VCR and DVD functions, which follow the standard function icons printed on top of the buttons.

For some products, however, the function of a particular button does not follow the command printed on the remote. In order to see which function a button controls, consult the Function List tables printed on page 30. To use those tables, first check the type of device being controlled (e.g., TV, VCR). Next, look at the remote control diagram pictured on page 29. Note that each button has a number on it.

To find out what function a particular button has for a specific device, find the button number on the Function List and then look in the column for the device you are controlling. For example, button number 9 is the Test Tone button for the AVR 500, but it is the "Favorite" button for many VCRs and Satellite receivers. Button number 34 is the Preset Tune Down button for the AVR 500, the "Reverse Skip" button for CD players and the "Page Down" button for some cable boxes.

Note that the numbers used to describe the button functions on page 29 for the purposes of describing how a button operates are a different set of numbers than those used in the rest of this manual to describe the button functions for the AVR.

Notes on Using the AVR 500 Remote With Other Devices.

- Manufacturers may use different code sets for the same product category. For that reason, it is important that you check to see if the code set you have entered operates as many controls as possible. If it appears that only a few functions operate, check to see if another code set will work with more buttons.
- When a button is pressed on the AVR 500 remote, the red light under the **Input or Remote Selector** ② ③ for the product being operated should flash briefly. If the Device Control Selector flashes for some but not all buttons for a particular product, it does NOT indicate a problem with the remote, but rather that no function is programmed for the button being pushed.

Macro Programming

Macros enable you to easily repeat frequently used combinations of commands with the press of a single button on the AVR's remote control. Once programmed, a macro will send out up to eight different remote codes in a pre-determined sequential order enabling you to automate the process of turning on your system, changing devices, or other common tasks. The AVR's remote can store up to five separate macro command sequences, one that is associated with the Power Button ④, and four more that are accessed by pressing the Macro Buttons ⑱ ⑲ ⑳.

- Press any of the **Input or Remote Selectors** ② ③ and the **Mute** button ⑥ at the same time until the red light under the Device Control Selector turns on.
- Press the button on the remote that you wish to use for this remote. This may be either the **Power** button ④ or any of the four Macro buttons ⑱ ⑲ ⑳. However, it is recommended that to avoid confusion, the Power button only be used to enter turn-on/turn-off sequences. When you press the button the macro will be programmed to, the light under **Selector** button ② ③ will blink once.
- Enter up to eight steps for the macro sequence by pressing the **Selector** button ② ③ for the device to be controlled and then pressing the button for the actual command step. Although the macro may contain up to eight steps, each button press, including those used to change devices, count as a step. The red light under the **Selector**

button ② ③ will blink once to confirm each button press as you enter commands.

NOTE: While entering commands for Power On/Off of any device during a macro sequence, press the **Mute** button ⑥. DO NOT press the actual Power button.

- When the eight steps have been entered, press the **Sleep** button ⑳ to enter the commands. The red light under the **Input or Remote Selectors** ② ③ will blink and then turn off.

Example: To program your TV, Cable Box and the AVR 500 to turn on when the Power button is pressed, first press and hold down the **AVR** ① and **Mute** buttons ⑥ until the red light comes on under the **AVR** button. Next, press the **Mute** button ⑥ to enter the Power command for the AVR. Press the **TV Device Control Selector** ③ to select the TV mode, and then press the **Mute** button ⑥ again, to select TV Power. Finally, press the **CBL Device Control Selector** ③ followed by the **Mute** button ⑥ to select Cable Power. Press the **Sleep** button ⑳ to enter the commands.

After following these steps, each time you press the **Power** button ④, the remote will send the Power On/Off command.

To remove a macro program, follow steps 1, 2 and 4 above, but ignore step three. For example, to erase the macro just entered, press the **Device Selector** ② ③ and the **Mute** button ⑥ at the same time until the red light under the Device Control Selector turns on. Press the **Power** button ④ and then press the **Sleep** button ⑳. The red light under the **Device Control Selector** will blink twice to confirm the data entry and then turn off.

Volume Punch-Through

The AVR 500's remote may be programmed to operate the **Volume Control** ⑳ from either the TV or the AVR to operate in conjunction with any of the eight devices controlled by the remote. For example, since the AVR 500 will likely be used as the sound system for TV viewing, you may wish to have the AVR's volume activated although the remote is set to run the TV. Either the AVR or TV volume control may be associated with any of the remote's devices. To program the remote for Volume Punch-Through, follow these steps:

Programming the Remote

1. Press the **Input or Remote Selector** **2** **3** for the unit you wish to have associated with the volume control and the **Mute** button **6** at the same time until the red light illuminates under the **Device Selector**.
2. Press the **Volume Up** button **32**.
3. Press either the **AVR** **1** or the **TV Device Control Selector** **3**, depending on which system's volume control you wish to have attached for the punch-through mode. Note that the red light under the **Device Control Selector** will blink twice and then go out to confirm the data entry.

Example: To have the AVR's volume control activated even though the remote is set to control the TV, first press the **TV Device Control Selector** **2** **3** and the **Mute** button **6** at the same time. Next, press the **Volume Up** button **32**, followed by the **AVR Device Control Selector** **1**.

NOTE: Should you wish to return the remote to the original configuration after entering a Volume Punch-Through, you will need to repeat the steps shown above. However, press the *same* Device Control Selector in steps one and three.

Reassigning Device-Control Selectors

Although each of the seven **Input or Remote Selectors** **2** **3** is normally assigned to the category of product shown on the remote, it is possible to reassign one of these buttons to operate a second device of another type. For example, if you have two VCRs but no satellite receiver, you may program the "SAT" button to operate a second VCR. Before following the nor-

mal programming steps for either Three-Digit entry or Auto Search code entry, you must first reassign the button with the following steps:

1. Press the **Input or Remote Selector** **2** **3** you wish to reassign and the **Mute** button **6** at the same time until the red light illuminates under the **Device Control Selector**.
2. Press the **Input or Remote Selector** **2** **3** for the function you wish to program into the reassigned button.
3. Enter the three-digit code for the specific model you wish the reassigned button to operate.
4. Press the same **Input or Remote Selector** **2** **3** pressed in Step 1 once again to store the selection.

Example: To use the SAT button to operate a second VCR, first press the **SAT Device Control Selector** **3** and the **Mute** button **6** at the same time until the red light glows under the SAT button. Press the VCR button, followed by the three-digit code for the specific model you wish to control. Finally, press the SAT button again.

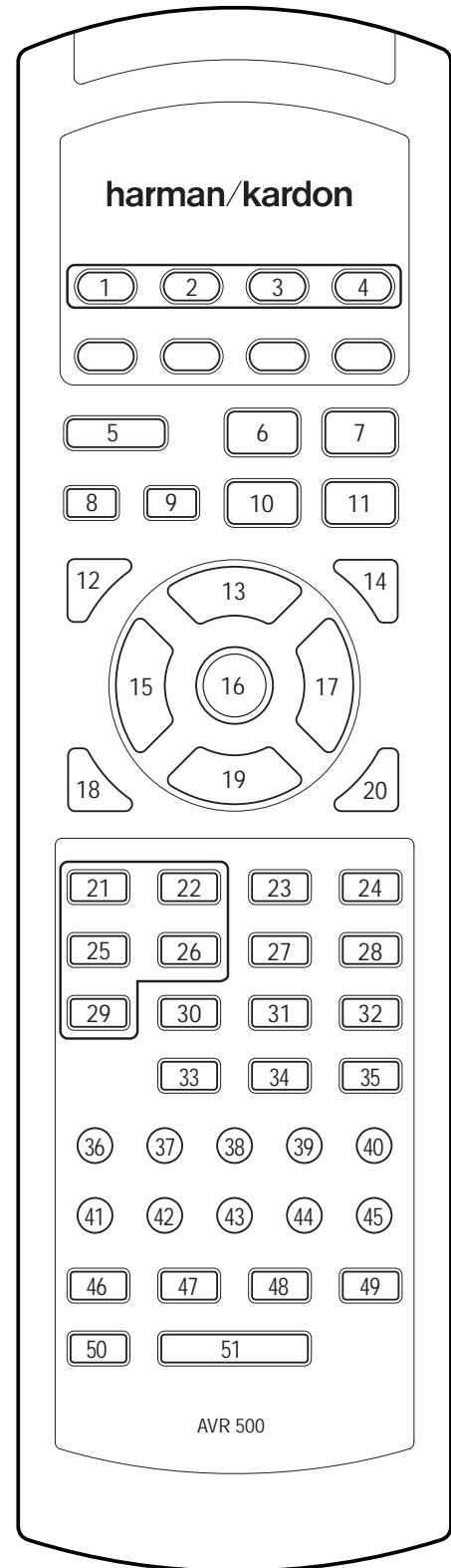

Function List

No.	Button Name	CD	Tape	Aux (DVD)	TV	VCR	CBL	SAT
1	AVR Selector							
2	CD Selector	Power On						
3	Tape Selector							
4	Aux/DVD Selector		Power On					
5	Power Off	Power Off		Power Off	Power On/Off	Power On/Off	Power On/Off	Power On/Off
6	Sleep	CDP Select		Skip Fwd	Channel +		Channel +	Channel +
7	Volume Up	Input Level Up		Skip Rev	Vol Up	Vol Up	Vol Up	Vol Up
8	Mute				Mute			
9	Test	Input Select					Fav	Fav
10	Surround Select	CDR Select			Channel -	Channel -	Channel -	Channel -
11	Volume Down	Input Level Down			Volume Down		Volume Down	Volume Down
12	Channel Select			Title	Guide	Guide	Guide	Guide
13	▲			Up	Up	Up	Up	Up
14	Speaker	Intro Scan		Menu	Menu	Menu	Menu	Menu
15	◀			Left	Left	Left	Left	Left
16	Set			Enter	Select	Select	Select	Select
17	▶			Right	Right	Right	Right	Right
18	Digital Select	Record		Subtitle	Exit	Exit	Exit	Exit
19	▼			Down	Down	Down	Down	Down
20	Delay	Open/Close		Return	Prev Channel		Prev Channel	Prev Channel
21	Vid 1 Select	Track Direct		Sub W On/Off			Music	Alt
22	6 Ch Select							
23	Night	Pause	Rec/Pause	Pause		Rec/Pause		
24	Multi Room	Stop	Stop	Stop		Stop		
25	Vid 2 Select	Track Increment		Open/Close				
26	AM/FM							
27	Transport Reverse		Play Reverse					
28	Transport Forward	Play	Play Forward	Play		Play		
29	Vid 3 Select	Disk Skip		Disk Skip				
30	Tuner Mode							
31	Tuning Down ◀◀	Rev Search	Rewind	Rev Search		Rewind	Day -	
32	Tuning Up ▶▶	Fwd Search	Fast Forward	Fwd Search		Fast Fwd	Day +	
33	Memory							
34	Preset ◀◀	Rev Skip		Rev Slow		Page -		
35	Preset ▶▶	Fwd Skip		Fwd Slow		Page +		
36	1	1		1	1	1	1	1
37	2	2		2	2	2	2	2
38	3	3		3	3		3	3
39	4	4		4	4		4	4
40	5	5		5	5		5	5
41	6	6		6	6		6	6
42	7	7		7	7		7	7
43	8	8		8	8		8	8
44	9	9		9	9		9	9
45	0	0		0	0		0	0
46	Macro 1	Time		Audio	Enter		Enter	Enter
47	Macro 2	Repeat		Angle			PPV	
48	Direct/Macro 3	Random Play		Chapter				
49	Clear/Macro 4	+ 10		Clear			Bypass	Next
50	OSD	Program						
51	Backlight						Info	Info

Setup Code Tables: TV

Manufacturer/Brand	Setup Code Number													
ADMIRAL	072	081	161											
AKAI	001	167												
AMPRO	073	167												
ANAM	043	054	055	056	080	104	108	112	118	121				
AOC	001	004	058	112										
CANDLE	001	002	003	004										
CAPEHART	058													
CENTRONIC	043													
CITIZEN	001	002	003	004	101	143								
CLASSIC	043													
CONCERTO	004													
CONTEC	043	051												
CRAIG	054													
CROWN	143													
CURTIS MATHES	001	004	101	143										
DAEWOO	004	055	103	111	114	127	143							
DAYTRON	004	143												
DWIN	177													
DYNATECH	062													
ELECTROHOME	024	143												
EMERSON	001	004	005	028	043	047	048	051	096	143	151	153	154	155
FISHER	007	057												
FUNAI	028	043												
FUTURETECH	043													
GE	004	008	009	034	056	073	074	091	130	144	155	160	161	
GOLDSTAR	004	106	110	112	113	119	127	143						
HITACHI	004	007	010	011	012	023	075	143	158	163				
INFINITY	164													
INKEL	129													
JBL	164													

Setup Code Tables: TV (continued)

Manufacturer/Brand	Setup Code Number											
JC PENNEY	004	008	024	030	065	101	143	160				
JENSEN	013											
JVC	034	038	070	083								
KENWOOD	001	070										
KLOSS	002	059										
KTV	043	143	154									
LUXMAN	004											
LXI	007	015	052	081	160	164						
MAGNAVOX	001	003	004	022	059	060	061	063	064	127	164	
MARANTZ	001	164										
MEMOREX	004	007	072									
METZ	088											
MGA	001	004	024	042								
MINERVA	088											
MITSUBISHI	004	024	040	042	109	146						
MTC	001	004	062	101								
NAD	015	025										
NEC	001	019	024	040	056	130	134					
OPTONICA	019	081										
PANASONIC	034	056	080	164								
PHILCO	001	003	004	024	056	059	060	063	064	127	143	164
PHILIPS	001	003	004	005	038	059	093	164				
PIONEER	004	018	023	025	135	176						
PORTLAND	004	143										
PROSCAN	144	160	161	167								
PROTON	004	058	143	171	173							
QUASAR	034	056										
RADIO SHACK	004	019	047	127	143							
RCA	001	004	023	024	056	065	074	144	152	156	160	161

Setup Code Tables: TV (continued)

Manufacturer/Brand	Setup Code Number											
REALISTIC	007	019	047									
RUNCO	072	169										
SAMPO	001	004	058									
SAMSUNG	004	101	127	133	143	160						
SANYO	007	020	021	033	053	057	082					
SCOTT	004	028	043	048	143							
SEARS	004	007	015	028	030	057	082	094	143	160		
SHARP	004	014	019	022	028	143	175					
SIGNATURE	072											
SONY	070	085	126	139								
SOUNDESIGN	003	004	028	043								
SUPRE MACY	002											
SYLVANIA	001	003	059	060	063	064	127	160	164			
SYMPHONIC	052											
TANDY	081											
TATUNG	056	062										
TECHNICS	034	080										
TECHWOOD	004											
TENIKA	002	003	004	028	043	072	101	143				
TERA	172											
TMK	004											
TOSHIBA	015	030	040	062	101							
TOTEVISION	143											
UNIVERSAL	008	009										
VIDEO CONCEPTS	146											
VIDIKRON	174											
VIDTECH	004											
WARDS	004	008	009	019	028	060	061	063	064	072	074	164
YAMAHA	004											
YORK	004											
ZENITH	072	073	095	103								

Setup Code Tables: VCR

Manufacturer/Brand	Setup Code Number											
AIWA	034											
ANAM	031	103										
AUDIO DYNAMICS	012	023	043									
BROKSONIC	035	037	129									
CANON	028	031										
CAPEHART	108											
CRAIG	001	040	135									
CURTIS MATHES	031	041										
DAEWOO	007	010	017	065	108	111						
DAYTRON	108											
DBX	012	023	043									
DYNATECH	034	053										
ELECTROHOME	059											
EMERSON	006	017	025	027	029	031	034	035	036	037	046	101
129	131	138	153									
FISHER	001	008	009	010								
FUNAI	034											
GE	031	063	072	107	109	144	147					
GO VIDEO	132	136										
GOLDSTAR	004	012	020	101								
HARMAN KARDON	012	045										
HITACHI	018	026	034	043	063	137	150					
INSTANTREPLAY	031											
JC PENNEY	004	012	040	101								
JENSEN	043											
JVC	012	031	043	046	055	060	130	150	152			
KENWOOD	014	034	048									
LLOYD	034											
LXI	001	004	009	017	034							
MAGNAVOX	031	034	041	067	068							
MARANTZ	012	031	067	069								
MARTA	101											
MATSUI	027	030										
MEI	031											
MEMOREX	001	010	014	031	034	040	053	072	101	134	139	
MGA	045	046	059									
MINOLTA	004	020										
MITSUBISHI	004	020	046	051	059	061	142					
MTC	034	040										
MULTITECH	024	034										
NEC	012	023	043	048								
NORDMENDE	043											

Setup Code Tables: VCR

Manufacturer/Brand	Setup Code Number										
OPTONICA	053	054									
PANASONIC	070	133	140								
PENTAX	004	020	031	063							
PHILCO	031	034	067								
PHILIPS	031	034	054	067	101						
PILOT	101										
PIONEER	004	021	048								
PORTLAND	108										
PULSAR	072										
QUARTZ	014										
RCA	004	020	034	040	041	107	109	140	144	147	
REALISTIC	001	008	010	014	031	034	040	053	054	101	
RICO	058										
SAMSUNG	017	040	107	109	113	115	124				
SANSUI	043	048	135								
SANYO	001	007	010	014	040	134					
SCOTT	017	037	129	131							
SEARS	001	004	008	009	010	014	017	020	081	101	
SHARP	031	054									
SHINTOM	024										
SONY	001	009	031	052	056	057	058				
SOUNDESIGN	034										
SYLVANIA	031	034	059	067							
SYMPHONIC	034										
TANDY	010	034									
TATUNG	043										
TEAC	034	043									
TECHNICS	031	070									
TEKNIKA	031	034	101								
THOMAS	034										
TMK	006										
TOSHIBA	004	008	017	059	082	131					
TOTEVISION	040	101									
UNITECH	040										
VECTOR RESEARCH	012										
VICTOR	048										
VIDEO CONCEPTS	012	034	046	141							
VIDEOSONIC	040										
WARDS	001	004	017	024	031	034	040	053	054	131	
YAMAHA	012	034	043								
ZENITH	034	048	056	058	072	080	101				

Setup Code Tables: CD

Manufacturer/Brand	Setup Code Number							
ADCOM	062	042						
AIWA	187	170						
AKAI	202	195						
CARVER	003	167	041	135	138	139	050	203
DENON	205	226						
HARMAN KARDON	047	033	208	001	002			
JVC	022	136	163					
KENWOOD	007	055	023	137	072	142		
MARANTZ	107	044						
MONDIAL	147							
NAD	215	005						
NAKAMICHI	217	218	219					
ONKYO	038	168	030					
OPTIMUS	049	085						
PANASONIC	068							
PIONEER	010	020	174					
REALISTIC	181	187	102					
RCA	012	150						
SHARP	013	051	066	031				
SHERWOOD	166	112	115	119	093			
SONY	225	097	126	133	081			
TEAC	062	131	015	182				
TECHNICS	068	200	008	060				
YAMAHA	012	054	024					

Setup Code Tables: DVD

Manufacturer/Brand	Setup Code Number
DENON	001
LG	010
MAGNAVOX	012
mitsubishi	002
PANASONIC	003
PHILIPS	012
PIONEER	004
PROSCAN	005
RCA	006
SAMSUNG	011
SONY	007
TOSHIBA	008
YAMAHA	009
JVC	012

Setup Code Tables: DVD/LD

Manufacturer/Brand	Setup Code Number
DAEWOO	024
DENON	030
GOLDSTAR	027
KENWOOD	025
MAGNAVOX	026
OPTIMUS	032
PANASONIC	021
PHILIPS	026
PIONEER	020 034
RCA	031
REALISTIC	032
SAMSUNG	023 029
SHARP	025 028
SONY	022
TECHNICS	021
TOSHIBA	025
YAMAHA	033

Setup Code Tables: CABLE

Manufacturer/Brand	Setup Code Number	Remote Control Model
PIONEER	001	BR-200
AMERICAST	005	
JERROLD	006	RT-J22 (CFT2200)
JERROLD	007	RT-J550C
PIONEER	002	BR-95
PIONEER	003	RT-P81/82
SCIENTIFIC-ATLANTIC	004	RT-S6X/USV86
TOCOM	010	RT-T7/T8
ZENITH	008	MN2500
ZENITH	009	RT-ZPMV

Setup Code Tables: SAT

Manufacturer/Brand	Setup Code Number
GE	001
ECHOSTAR	006
HITACHI	001 012
HUGHES	003
PANASONIC	013
PRIMESTAR	002
PRIMESTAR	005
RCA	001
SONY	004
TOSHIBA	008
UNIDEN	009 010

Troubleshooting Guide

SYMPTOM	CAUSE	SOLUTION
Unit does not function when Power Switch is pushed	<ul style="list-style-type: none"> No AC Power 	<ul style="list-style-type: none"> Make certain AC power cord is plugged into a live outlet Check to see if outlet is switch controlled
Display lights, but no sound or picture	<ul style="list-style-type: none"> Intermittent input connections Mute is on Volume control is down 	<ul style="list-style-type: none"> Make certain that all input and speaker connections are secure Press Mute button Turn up volume control
Unit turns on, but Front-Panel Display does not light up	<ul style="list-style-type: none"> Display brightness is turned off. 	<ul style="list-style-type: none"> Follow the instructions in the Display Brightness section on page 20 so that the display is set to VFD FULL
No sound from any speaker; Light around power switch is red	<ul style="list-style-type: none"> Amplifier is in protection mode due to possible short Amplifier is in protection mode due to internal problems 	<ul style="list-style-type: none"> Check speaker-wire connections for shorts at receiver and speaker ends Contact your local Harman Kardon service depot
No sound from surround or center speakers	<ul style="list-style-type: none"> Incorrect surround mode Input is monaural Incorrect configuration Stereo or Mono program material 	<ul style="list-style-type: none"> Select a mode other than Stereo There is no surround information from mono sources Check speaker mode The surround decoder may not create center- or rear-channel information from nonencoded programs
Unit does not respond to remote commands	<ul style="list-style-type: none"> Weak batteries in remote Wrong device selected Remote sensor is obscured 	<ul style="list-style-type: none"> Change remote batteries Press the AVR selector Make certain front-panel sensor is visible to remote or connect remote sensor
Intermittent buzzing in tuner	<ul style="list-style-type: none"> Local interference 	<ul style="list-style-type: none"> Move unit or antenna away from computers, fluorescent lights, motors or other electrical appliances

Processor Reset

In the rare case where the unit's operation or the displays seem abnormal, the cause may involve the erratic operation of the system's memory or microprocessor.

To correct this problem, first unplug the unit from the AC wall outlet and wait at least three minutes. After the pause, reconnect the AC power cord and check the unit's operation. If the system still malfunctions, a system reset may clear the problem.

To clear the AVR 500's entire system memory including tuner presets, output level settings, delay times and speaker configuration data, first turn the unit off by pressing and releasing

the **Main Power Switch 1** so that it pops out from its normal recessed position. Next, press and hold the **AM/FM 14** and the **Dolby Pro Logic 20** buttons while pushing in the **Main Power Switch 1** to turn the unit back on. Note that once you have cleared the memory in this manner, it is necessary to re-establish all system configuration settings and tuner presets.

NOTE: Resetting the processor will erase any configuration settings you have made for speakers, output levels, surround modes, digital input assignments as well as the tuner presets. After a reset the unit will be returned to the factory presets, and all settings for these items must be reentered.

If the system is still operating incorrectly, there may have been an electronic discharge or severe AC line interference that has corrupted the memory or microprocessor.

If these steps do not solve the problem, consult an authorized Harman Kardon service depot.

Technical Specifications

Audio Section

Stereo Mode

Continuous Average Power (FTC)

80 Watts per channel, 20Hz–20kHz,
@ < 0.07% THD, both channels driven into 8 ohms

Five-Channel Surround Modes

Power Per Individual Channel

Front L&R channels:
70 Watts per channel,
@ < 0.07% THD, 20Hz–20kHz into 8 ohms

Center channel:
70 Watts, @ < 0.07% THD, 20Hz–20kHz into 8 ohms

Surround channels:
70 Watts per channel,
@ < 0.07% THD, 20Hz–20kHz into 8 ohms

Input Sensitivity/Impedance

Linear (High Level) 200mV/47 kohms

Signal-to-Noise Ratio (IHF-A) 95dB

Surround System Adjacent Channel Separation

Analog Decoding 40dB
(Pro Logic, etc.)

Dolby Digital (AC-3) 55dB
DTS 55dB

Frequency Response

@ 1W (+0dB, -3dB) 10Hz–100kHz

High Instantaneous

Current Capability (HCC) ±45 Amps

Transient Intermodulation

Distortion (TIM) Unmeasurable

Rise Time 16 µsec

Slew Rate 40V/µsec

FM Tuner Section

Frequency Range	87.5–108MHz
Usable Sensitivity	IHF 1.3 µV/13.2dBf
Signal-to-Noise Ratio	Mono/Stereo 70/68dB
Distortion	Mono/Stereo 0.3/0.3%
Stereo Separation	40dB @ 1kHz
Selectivity	±400kHz, 65dB
Image Rejection	80dB
IF Rejection	90dB
Tuner Output Level	1kHz, ±75kHz Dev 500mV

AM Tuner Section

Frequency Range	520–1710kHz
Signal-to-Noise Ratio	45dB
Usable Sensitivity	Loop 500µV
Distortion	1kHz, 50% Mod 0.8%
Selectivity	±10kHz, 30dB

Video Section

Video Format	NTSC
Input Level/Impedance	1Vp-p/75 ohms
Output Level/Impedance	1Vp-p/75 ohms
Video Frequency Response	10Hz–8MHz (-3dB)

General

Power Requirement	AC 120V/60Hz
Power Consumption	78W idle, 694W maximum (2 channels driven)

Dimensions (Max)

Width	17.3 inches (440mm)
Height	6.5 inches (165mm)
Depth	17.1 inches (435mm)
Weight	34 lb (15.4 kg)

Depth measurement includes knobs, buttons and terminal connections.

Height measurement includes feet and chassis.

All features and specifications are subject to change without notice.

Harman Kardon is a registered trademark, and Power for the Digital Revolution is a trademark, of Harman International Industries, Inc.

*Manufactured under license from Dolby Laboratories.

"Dolby," "Pro Logic," "AC-3" and the Double-D symbol are trademarks of Dolby Laboratories. Confidential Unpublished Works. ©1992–1999 Dolby Laboratories, Inc. All rights reserved.

† DTS and DTS Surround are trademarks of Digital Theater Systems, Inc.

†† UltraStereo is a trademark of UltraStereo Corp.

VMAx is a trademark of Harman International Industries, Inc., and is an implementation of Cooper Bauck Transaural Stereo under patent license.

Logic 7 is a registered trademark of Lexicon, Inc.